

# INDEX



**MIKONOS** P.6



**CRETA** P.24



**MAUI** P.36



**CANARIAS** P.54



**BORA** P.74



INTEGRAL AESTHETICS FOR POOLS AND TERRACES  
ESTÉTICA INTEGRAL PARA PISCINA Y TERRAZA



**HAWAII** P.88



**VIERTEAGUAS** P.106



**STEP/PELDAÑO 120X33** P.112



**CERAMIC GRATES**  
**REJILLAS CERÁMICAS** P.118



**ADDITIONAL INFORMATION**  
**INFORMACIÓN ADICIONAL** P.131



**NON SLIP TERRACES**  
**TERRAZAS ANTIDESLIZANTES** P.139



**CERÁMICA MAYOR, S.A.**  
Partida Planet, s/n  
03510 Callosa d'En Sarrià  
(Alicante-España)

T+34 965 881 175  
www.ceramicamayor.com



# 10 Reasons to enjoy your pool

## Razones para disfrutar de tu piscina



INTEGRAL AESTHETICS FOR POOLS AND TERRACES  
ESTÉTICA INTEGRAL PARA PISCINA Y TERRAZA



**INTEGRAL AESTHETICS FOR POOL AND TERRACES.** A terrace with a single design and forget about having cutting areas between the terrace and pool.

**ESTÉTICA INTEGRAL PARA PISCINA Y TERRAZA.** Una terraza con un solo diseño 360º y olvídate de tener zonas de corte entre la terraza y la piscina.

2



**WHICH IS THE POOL OF YOUR DREAMS ?.** Infinity, lagoon, indoor, wellness, traditional or contemporary. We can do it!

**¿CUÁL ES LA PISCINA DE TUS SUEÑOS?.** Infinity, laguna, indoor, wellness, tradicionales o contemporáneas. ¡Podemos hacerlo!

3



**ANTISLIP.** Avoid accidents and falls with a material that meets outdoor requirements.

**ANTIDESLIZANTE.** Evita accidentes y caídas tontas con un material que cumple la normativa obligatoria para exteriores.

4



**LONG LIFE PRODUCT.** Porcelain stoneware is a material that does not deteriorate over the years. Build long-term thinking.

**PARA TODA LA VIDA.** El gres porcelánico es un material que no se deteriora con el paso del tiempo. Construye pensando a largo plazo.

5



**INTELLIGENT SYSTEMS,** combinable with each other to find the best solution to all types of swimming pools.

**SISTEMAS INTELIGENTES,** combinables entre si para encontrar la mejor solución constructiva a todo tipo de piscinas.

6



**ATHERMAL FEELING.** Do not burn your feet. Our Mikonos & Hawaii systems reduce 30% the heat feeling.

**SENSACIÓN TÉRMICA.** No te quemes los pies. Nuestros sistemas Mikonos y Hawaii disminuyen un 30% la sensación térmica al contacto.

7



**CUSTOMIZATION AND WARNING SIGNALING.** If your project requires it we can customize or signal our systems by printing.

**PERSONALIZACIÓN Y SEÑALIZACIONES DE ADVERTENCIA.** Si su proyecto lo requiere podemos personalizar o señalar nuestros sistemas mediante impresión.

8



**IDEAL FOR REHABILITATIONS.** It easily adapts to existing swimming pools due to its standard dimensions.

**IDEAL PARA REHABILITACIONES.** Se acopla fácilmente a piscinas ya existentes gracias a sus dimensiones estándar.

9



**RESISTANT SPECIAL POOL CHEMICALS.** Material that does not stain or alters with the additives they put into the pool water for maintenance.

**RESISTENTE A PRODUCTOS QUÍMICOS PARA PISCINAS.** Material que no se mancha ni altera con los aditivos que se le ponen al agua de la piscina para su mantenimiento.

10



**EASY MAINTENANCE.** Material easy to clean with hose or karcher. Invest time in enjoying life.

**FÁCIL MANTENIMIENTO.** Material de fácil limpieza con manguera o karcher e invierte el tiempo en disfrutar.

# 10

Reasons to enjoy your pool  
Razones para disfrutar de tu piscina



INTEGRAL AESTHETICS FOR POOLS AND TERRACES  
ESTÉTICA INTEGRAL PARA PISCINA Y TERRAZA



**INTEGRAL AESTHETICS FOR POOL AND TERRACES.** A terrace with a single design and forget about having cutting areas between the terrace and pool.

**ESTÉTICA INTEGRAL PARA PISCINA Y TERRAZA.** Una terraza con un solo diseño 360º y olvídate de tener zonas de corte entre la terraza y la piscina.

2



**WHICH IS THE POOL OF YOUR DREAMS ?.** Infinity, lagoon, indoor, wellness, traditional or contemporary. We can do it!

**¿CUÁL ES LA PISCINA DE TUS SUEÑOS?.** Infinity, laguna, indoor, wellness, tradicionales o contemporáneas. ¡Podemos hacerlo!

3



**ANTISLIP.** Avoid accidents and falls with a material that meets outdoor requirements.

**ANTIDESLIZANTE.** Evita accidentes y caídas tontas con un material que cumple la normativa obligatoria para exteriores.

4



**LONG LIFE PRODUCT.** Porcelain stoneware is a material that does not deteriorate over the years. Build long-term thinking.

**PARA TODA LA VIDA.** El gres porcelánico es un material que no se deteriora con el paso del tiempo. Construye pensando a largo plazo.

5



**INTELLIGENT SYSTEMS,** combinable with each other to find the best solution to all types of swimming pools.

**SISTEMAS INTELIGENTES,** combinables entre si para encontrar la mejor solución constructiva a todo tipo de piscinas.

6



**ATHERMAL FEELING.** Do not burn your feet. Our Mikonos & Hawaii systems reduce 30% the heat feeling.

**SENSACIÓN TÉRMICA.** No te quemes los pies. Nuestros sistemas Mikonos y Hawaii disminuyen un 30% la sensación térmica al contacto.

7



**CUSTOMIZATION AND WARNING SIGNALING.** If your project requires it we can customize or signal our systems by printing.

**PERSONALIZACIÓN Y SEÑALIZACIONES DE ADVERTENCIA.** Si su proyecto lo requiere podemos personalizar o señalar nuestros sistemas mediante impresión.

8



**IDEAL FOR REHABILITATIONS.** It easily adapts to existing swimming pools due to its standard dimensions.

**IDEAL PARA REHABILITACIONES.** Se acopla fácilmente a piscinas ya existentes gracias a sus dimensiones estándar.

9



**RESISTANT SPECIAL POOL CHEMICALS.** Material that does not stain or alters with the additives they put into the pool water for maintenance.

**RESISTENTE A PRODUCTOS QUÍMICOS PARA PISCINAS.** Material que no se mancha ni altera con los aditivos que se le ponen al agua de la piscina para su mantenimiento.

10



**EASY MAINTENANCE.** Material easy to clean with hose or karcher. Invest time in enjoying life.

**FÁCIL MANTENIMIENTO.** Material de fácil limpieza con manguera o karcher e invierte el tiempo en disfrutar.

# 10

Reasons to enjoy your pool  
Razones para disfrutar de tu piscina



INTEGRAL AESTHETICS FOR POOLS AND TERRACES  
ESTÉTICA INTEGRAL PARA PISCINA Y TERRAZA

1



**INTEGRAL AESTHETICS FOR POOL AND TERRACES.** A terrace with a single design and forget about having cutting areas between the terrace and pool.

**ESTÉTICA INTEGRAL PARA PISCINA Y TERRAZA.** Una terraza con un solo diseño 360º y olvídate de tener zonas de corte entre la terraza y la piscina.

2



**WHICH IS THE POOL OF YOUR DREAMS ?.** Infinity, lagoon, indoor, wellness, traditional or contemporary. We can do it!

**¿CUÁL ES LA PISCINA DE TUS SUEÑOS?.** Infinity, laguna, indoor, wellness, tradicionales o contemporáneas. ¡Podemos hacerlo!

3



**ANTISLIP.** Avoid accidents and falls with a material that meets outdoor requirements.

**ANTIDESLIZANTE.** Evita accidentes y caídas tontas con un material que cumple la normativa obligatoria para exteriores.

4



**LONG LIFE PRODUCT.** Porcelain stoneware is a material that does not deteriorate over the years. Build long-term thinking.

**PARA TODA LA VIDA.** El gres porcelánico es un material que no se deteriora con el paso del tiempo. Construye pensando a largo plazo.

5



**INTELLIGENT SYSTEMS,** combinable with each other to find the best solution to all types of swimming pools.

**SISTEMAS INTELIGENTES,** combinables entre si para encontrar la mejor solución constructiva a todo tipo de piscinas.

6



**ATHERMAL FEELING.** Do not burn your feet. Our Mikonos & Hawaii systems reduce 30% the heat feeling.

**SENSACIÓN TÉRMICA.** No te quemes los pies. Nuestros sistemas Mikonos y Hawaii disminuyen un 30% la sensación térmica al contacto.

7



**CUSTOMIZATION AND WARNING SIGNALING.** If your project requires it we can customize or signal our systems by printing.

**PERSONALIZACIÓN Y SEÑALIZACIONES DE ADVERTENCIA.** Si su proyecto lo requiere podemos personalizar o señalar nuestros sistemas mediante impresión.

8



**IDEAL FOR REHABILITATIONS.** It easily adapts to existing swimming pools due to its standard dimensions.

**IDEAL PARA REHABILITACIONES.** Se acopla fácilmente a piscinas ya existentes gracias a sus dimensiones estándar.

9



**RESISTANT SPECIAL POOL CHEMICALS.** Material that does not stain or alters with the additives they put into the pool water for maintenance.

**RESISTENTE A PRODUCTOS QUÍMICOS PARA PISCINAS.** Material que no se mancha ni altera con los aditivos que se le ponen al agua de la piscina para su mantenimiento.

10



**EASY MAINTENANCE.** Material easy to clean with hose or karcher. Invest time in enjoying life.

**FÁCIL MANTENIMIENTO.** Material de fácil limpieza con manguera o karcher e invierte el tiempo en disfrutar.



CRETA



**SKIMMER SYSTEM**  
SISTEMA SKIMMER

Creta System + RJ67 Grate System  
Color: Stromboli Light



**CRETA EDGE**  
BORDE CRETA  
Ref. BPCR 0000 33x50 **(M-754) pz**  
**MONOBLOCK**

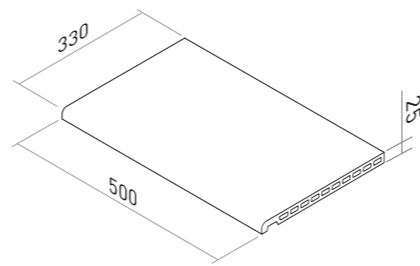

**CERAMIC DRAIN GRATE**  
REJILLA DE DRENAJE CERÁMICA  
Ref. RJ67 0000 25x50 **(M-780) pz**  
**MONOBLOCK**

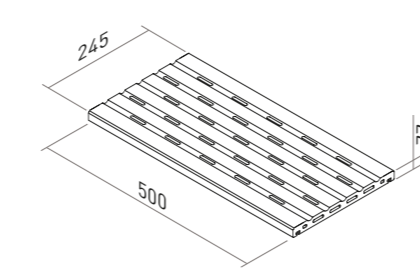

**ANTISHOCK**



Component: Grate Rubber included  
Componente: Goma p/Rejilla incluida  
Art. 7966 **(M-771) ml**

Breaking Load  
Fuerza de rotura **>3500N**

EN ISO 10545-4

Drain  
Desagüe

**> 19.7 m³/hora**



STROMBOLI\_light



**SKIMMER SYSTEM DETAIL**  
DETALLE SISTEMA SKIMMER

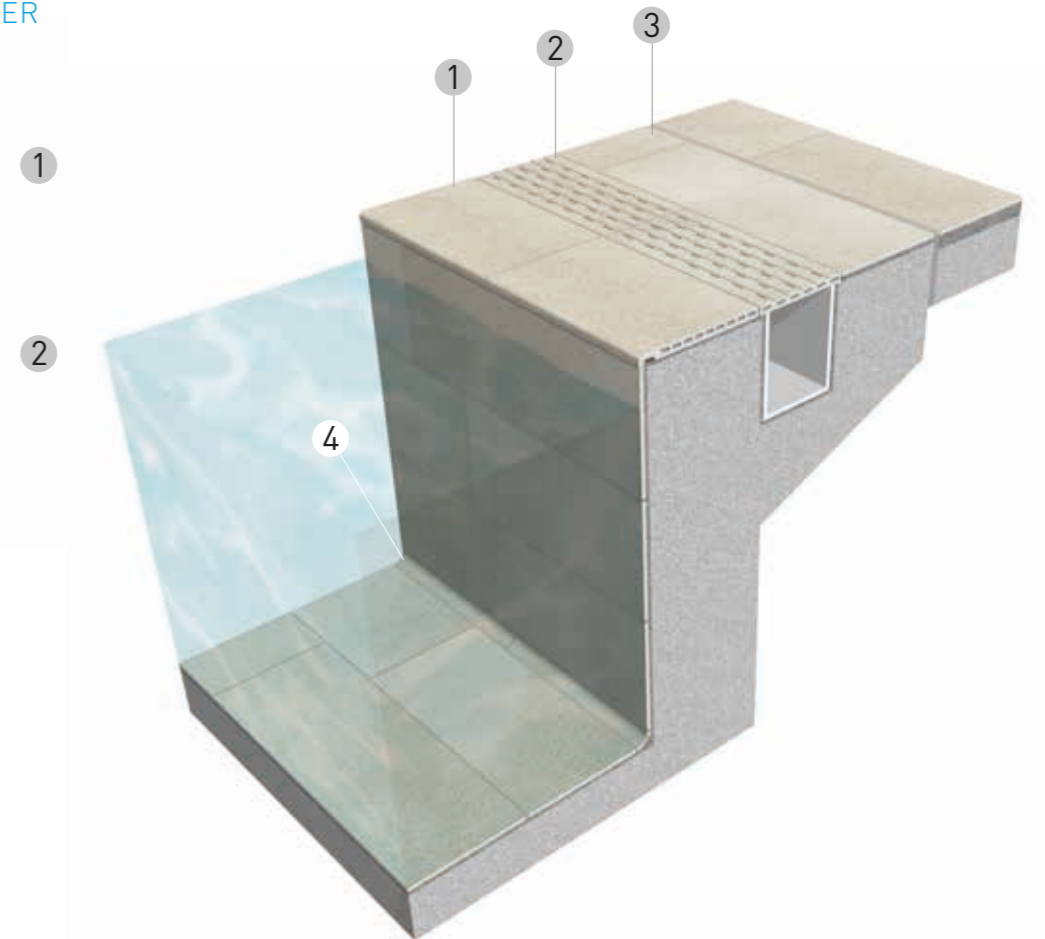

- 1\_ CRETA EDGE  
BORDE CRETA
- 2\_ CERAMIC GRATE RJ67  
REJILLA CERÁMICA RJ67
- 3\_ TILES  
BASES
- 4\_ COVE POOL  
MEDIA CAÑA

**TECHNICAL INFORMATION**  
INFORMACIÓN TÉCNICA

**MONOBLOCK** ONE PIECE WITHOUT GLUED  
UNA PIEZA, SIN PEGADO



**WIDER EXTRA EDGE SOLUTION**  
SOLUCIÓN PARA UN BORDE MÁS ANCHO

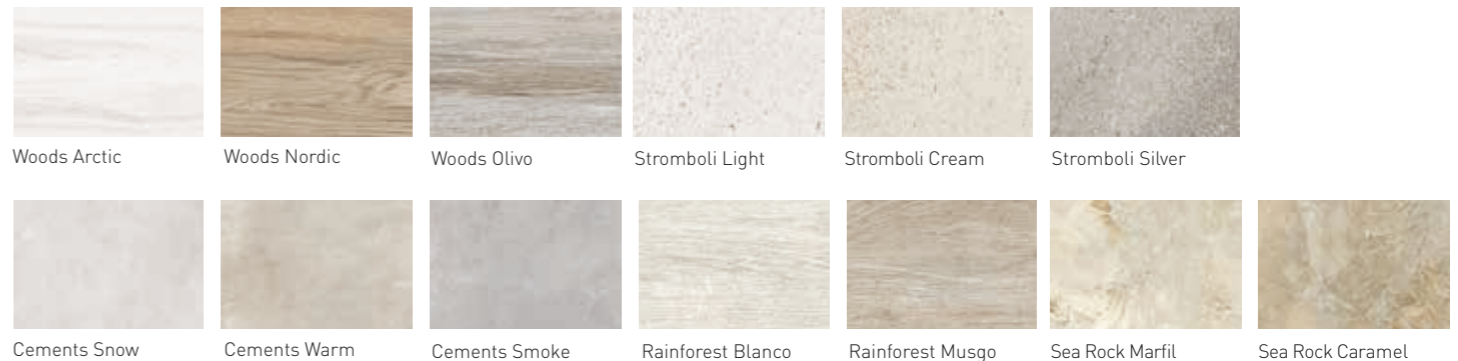
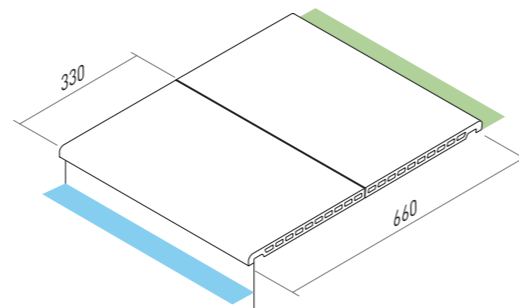

**CORNER SOLUTION**  
SOLUCIÓN ESQUINA



**CERAMIC GRATE CORNER PACK**  
PACK ESQUINA REJILLA CERÁMICA  
① Ref. RJ67 E000 25x50 **(M-781) 2pz**

**CRETA EDGE CORNER PACK**  
PACK ESQUINA BORDE CRETA  
② Ref. BPCR EI00 33x50 **(M-755) 2pz**  
③ Ref. BPCR EE00 33x50 **(M-755) 2pz**

**CURVED SOLUTION**  
SOLUCIÓN CURVA



Special Projects, consult factory. Extra cost Ref. 6624 (M-600) pz  
Proyectos especiales consultar con fábrica. Coste extra Ref. 6624 (M-600) pz



**CURVE CERAMIC GRATE**  
REJILLA CERÁMICA CURVA  
① Ref. RJ67 RI00 **(M-782) pz**  
③ Ref. RJ67 RE00 **(M-782) pz**

**CRETA CURVE EDGE**  
BORDE CURVO CRETA  
② Ref. BPCR RI00 33x50 **(M-756) pz**  
④ Ref. BPCR RE00 33x50 **(M-756) pz**





## Creta detail system

Detalle del sistema Creta

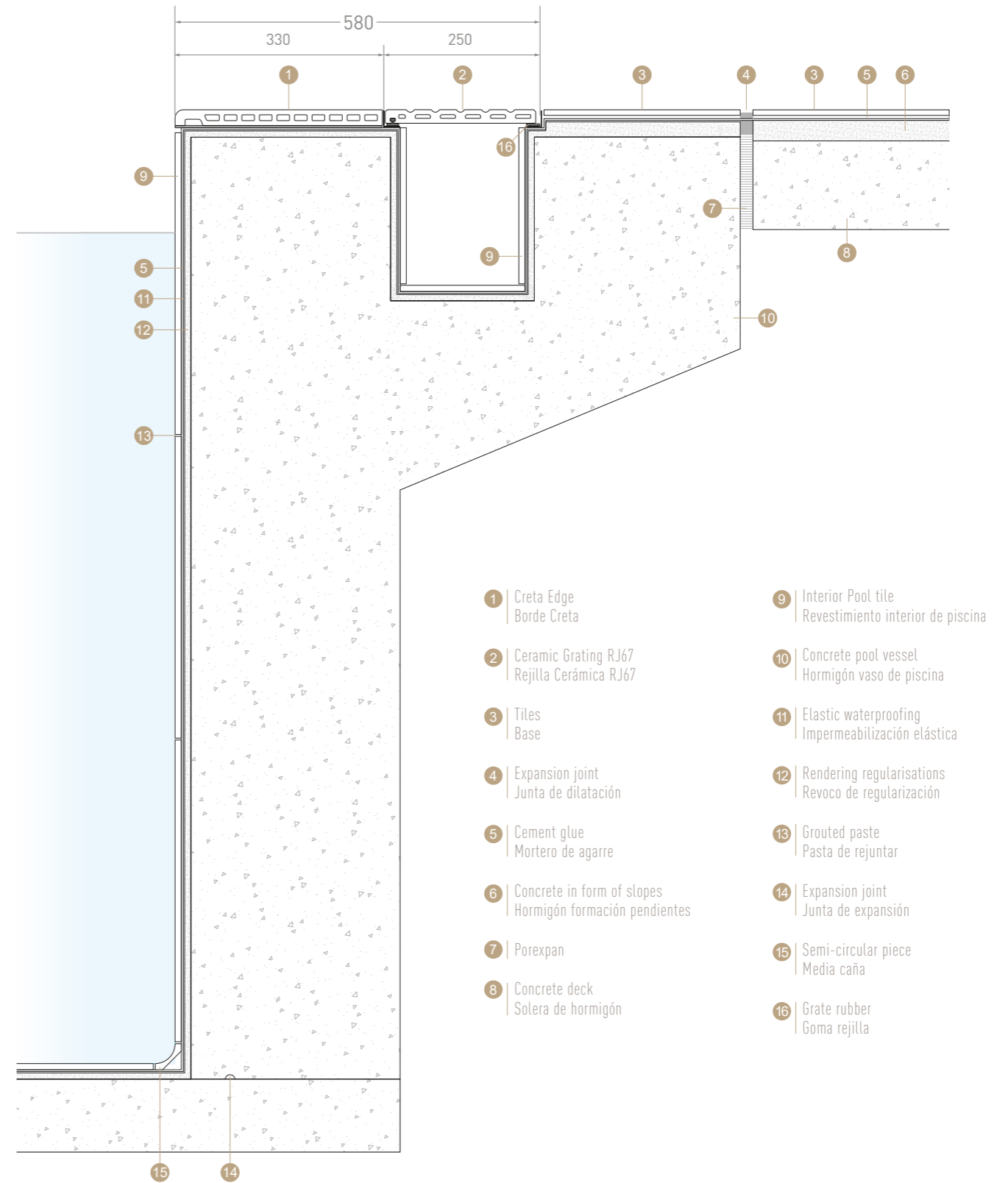

## Straight system pieces with RJ66 Grate

Sistema de piezas en recto con Rejilla RJ67

DWG CR\_170701



**RJ67 0000 ceramic grate**  
Rejilla cerámica RJ67 0000

**Creta System**  
Sistema Creta

**Ceramic grate**  
Rejilla cerámica  
Ref. RJ67 0000 25x50

**Creta pool edge**  
Borde piscina Creta  
Ref. BPCR 0000 33x50

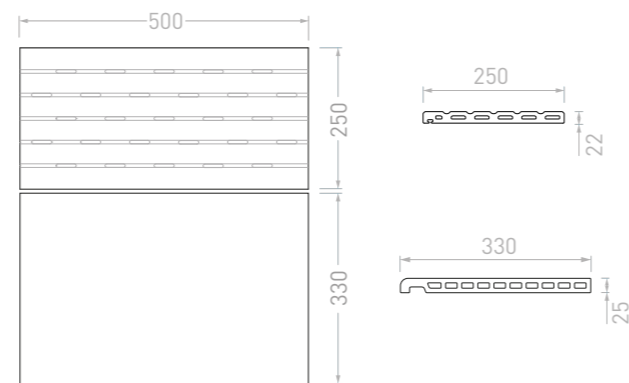

## Straight system pieces with RJ70 Grate

Sistema de piezas en recto con Rejilla RJ70

DWG CR\_170701

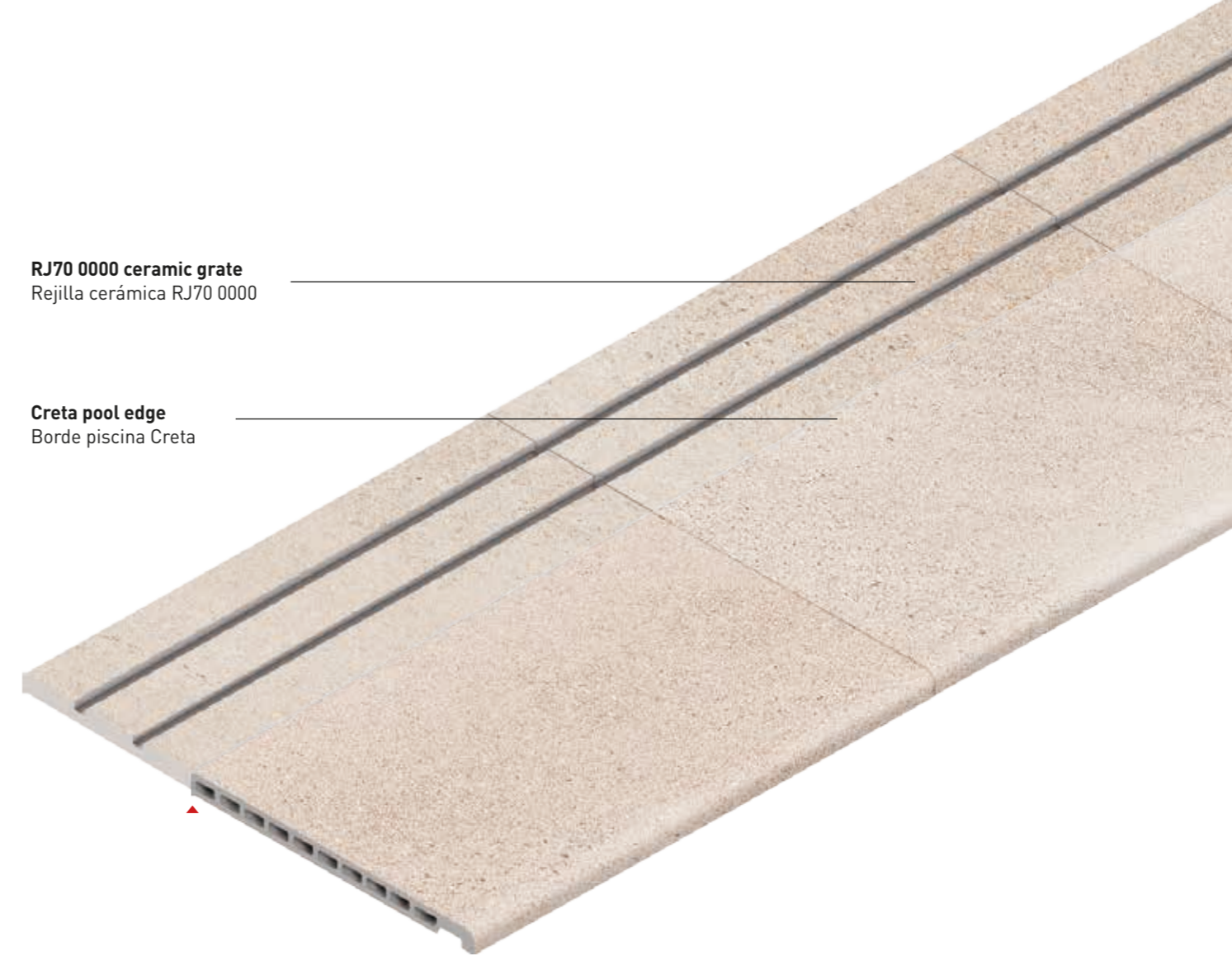

**RJ70 0000 ceramic grate**  
Rejilla cerámica RJ70 0000

**Creta pool edge**  
Borde piscina Creta

**Ceramic grate**  
Rejilla cerámica  
Ref. RJ70 0000 20x50

**Creta pool edge**  
Borde piscina Creta  
Ref. BPCR 0000 33x50

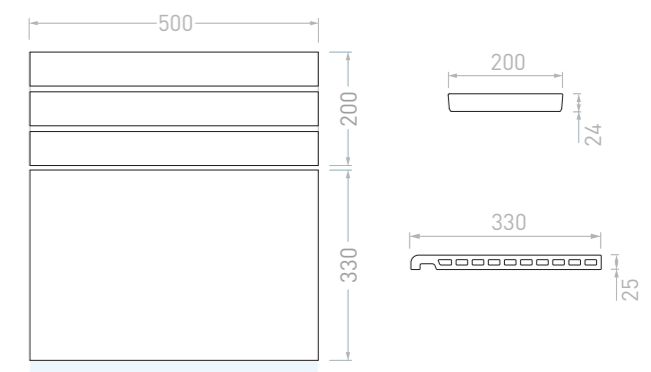

# Corner Solutions with RJ67 Grate system

Soluciones de esquina con el sistema de Rejilla RJ67

DWG CR\_190314

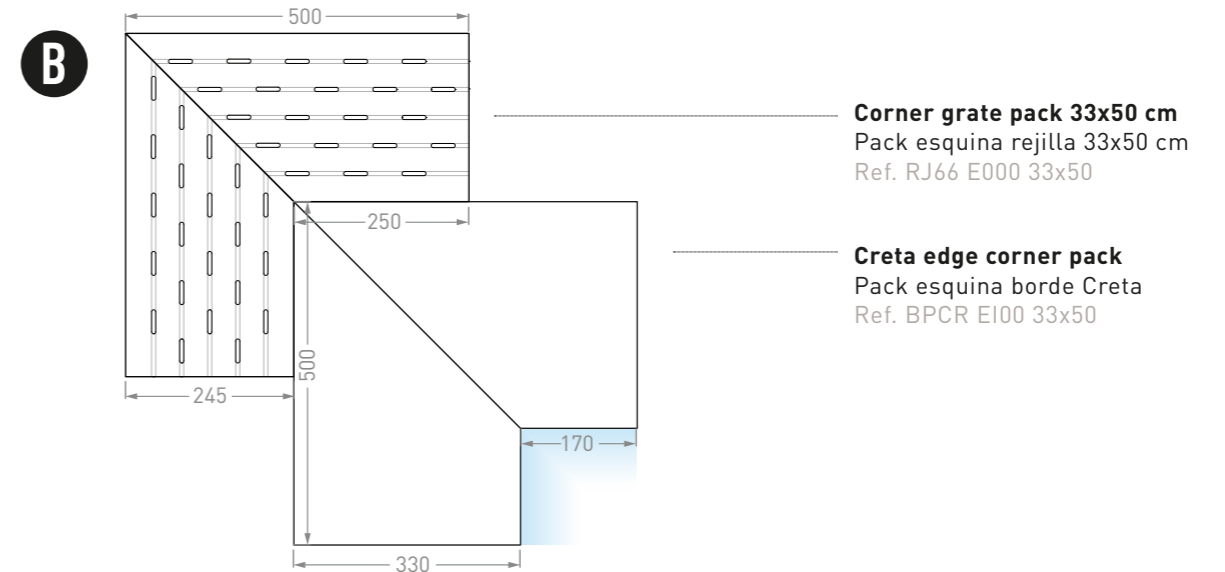
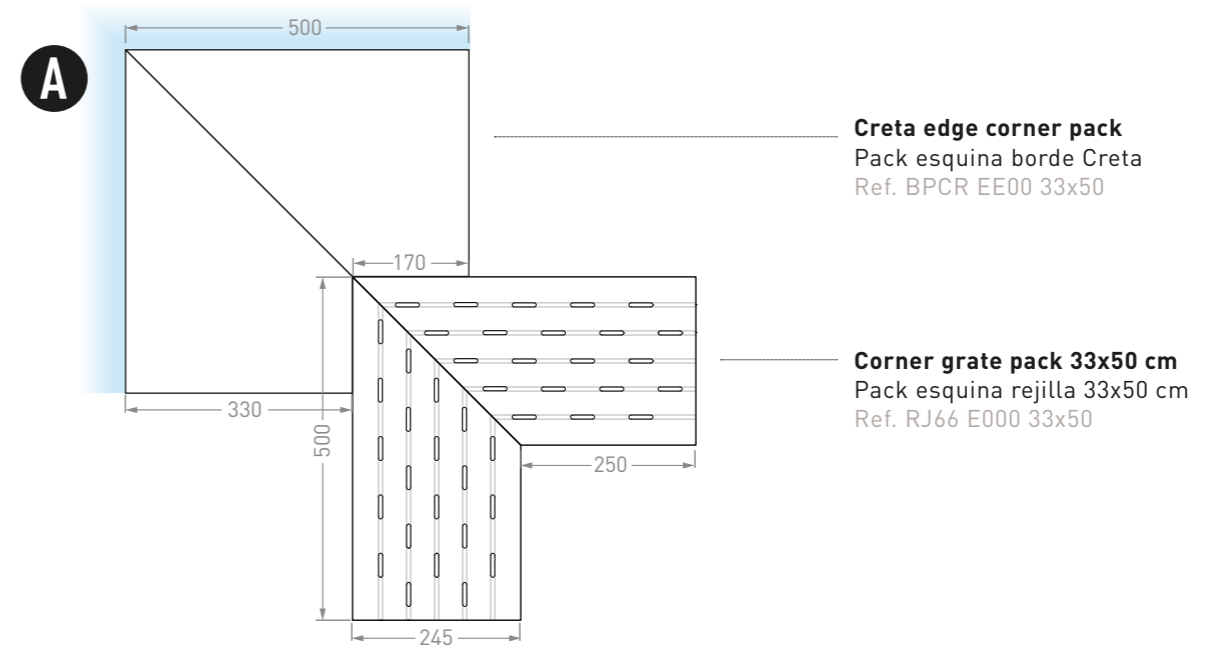
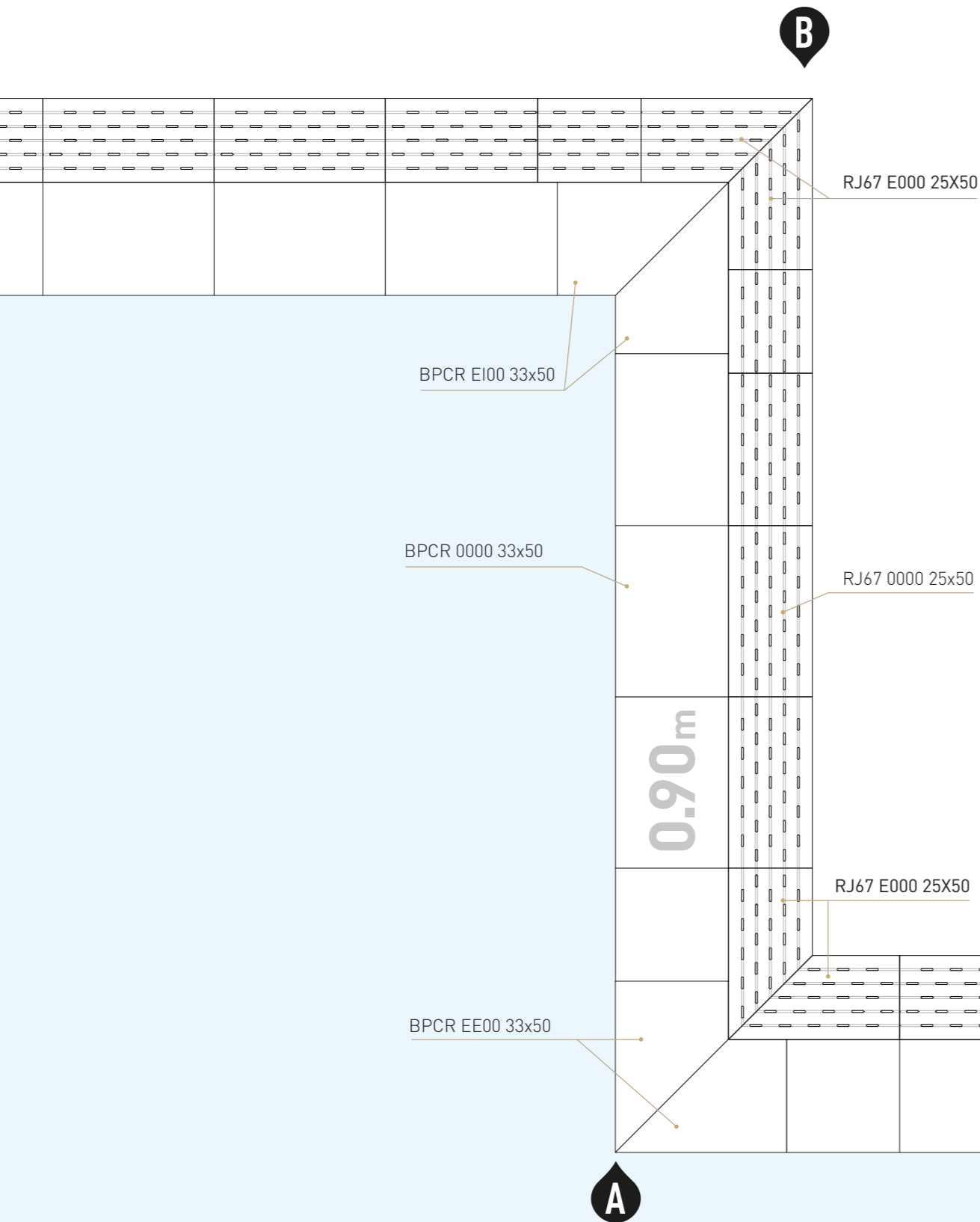

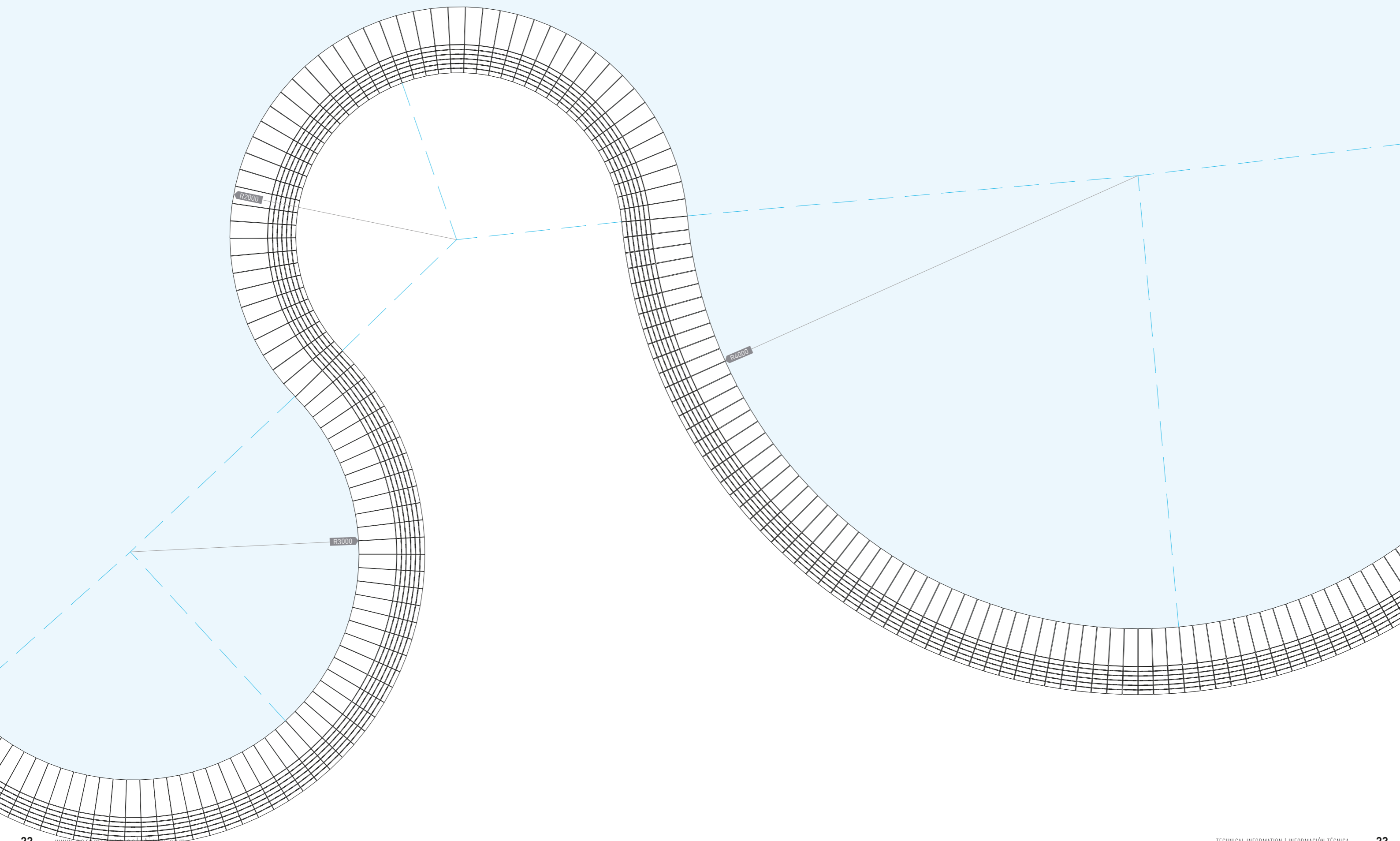

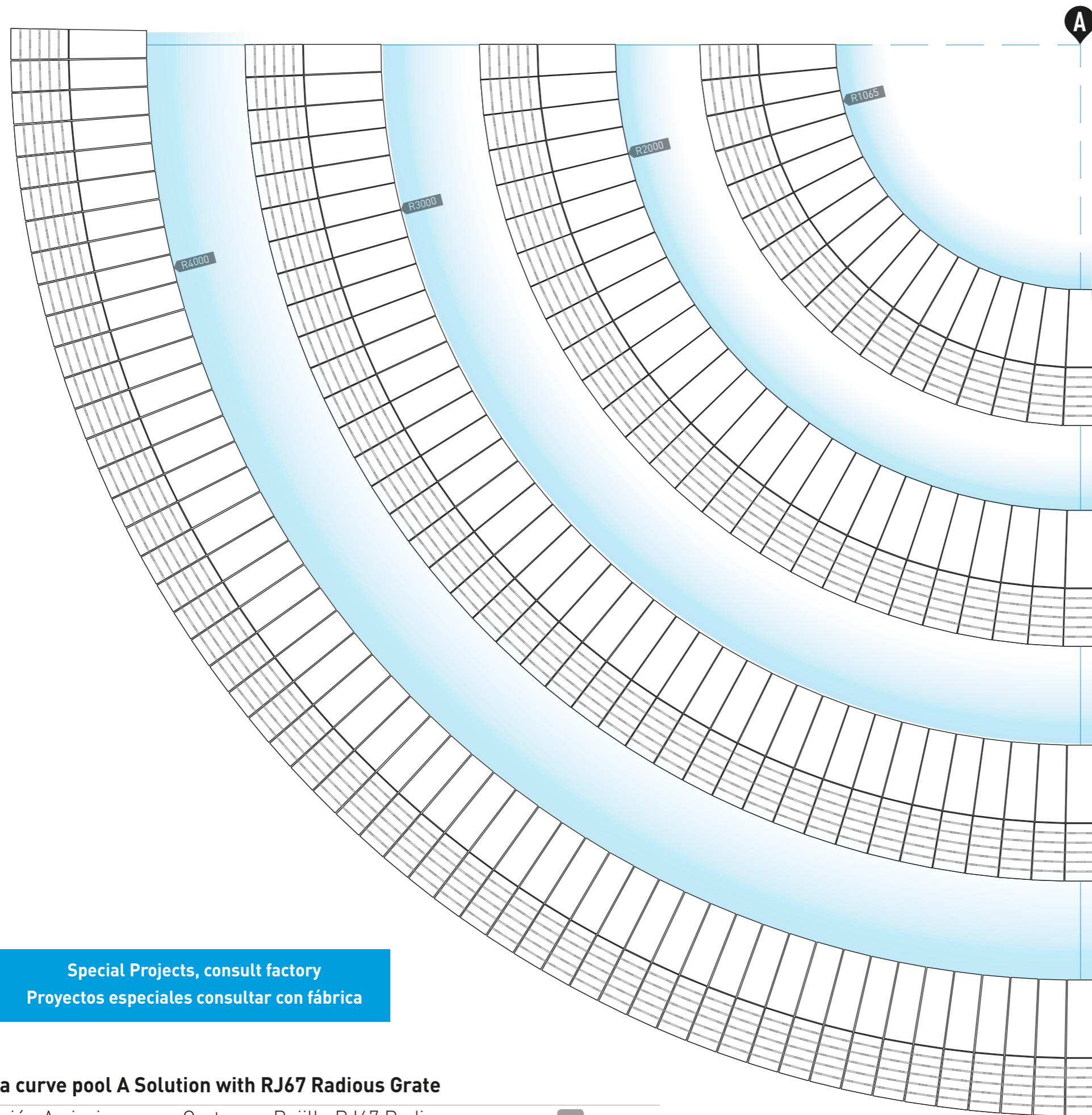

RJ67 RI01 GRATE  
REJILLA RJ67 RI01

CRETA CURVE EDGE  
BORDE CURVO CRETA

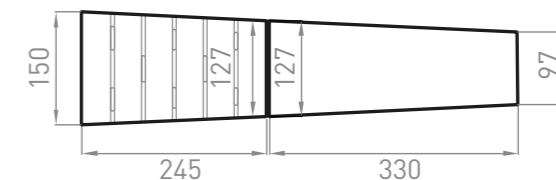

RADIO 1.06 m

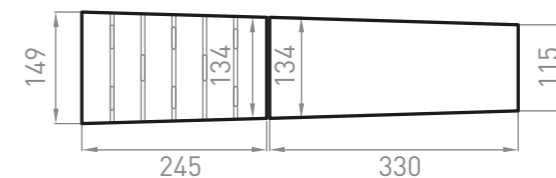

RADIO 2.00 m

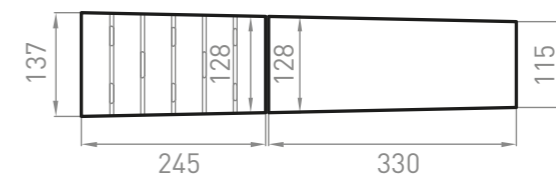

RADIO 3.00 m

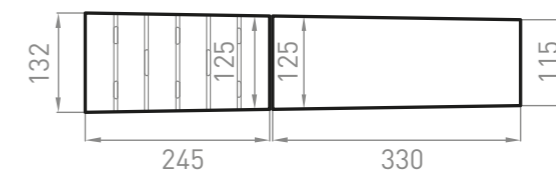

RADIO 4.00 m

Special Projects, consult factory  
Proyectos especiales consultar con fábrica

**Creta curve pool A Solution with RJ67 Radius Grate**

Solución A piscina curva Creta con Rejilla RJ67 Radio

DWG CR\_170701

**Creta curve pool B Solution with RJ67 Radius Grate**

Solución B piscina curva Creta con Rejilla RJ67 Radio

DWG CR\_170701

RADIO 4.00 m

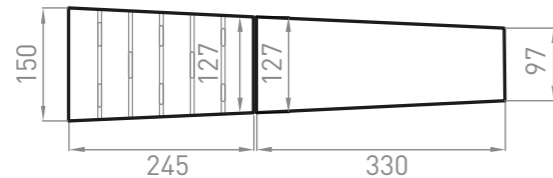

RADIO 3.00 m

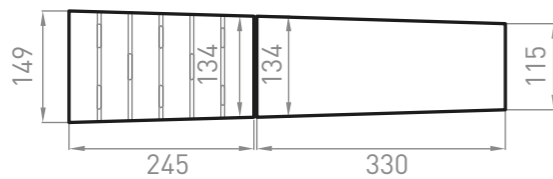

RADIO 2.00 m

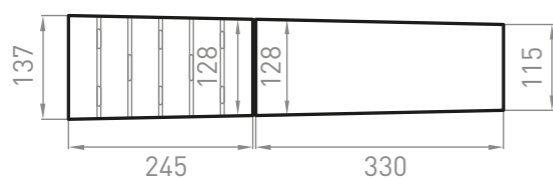

RADIO 1.06 m

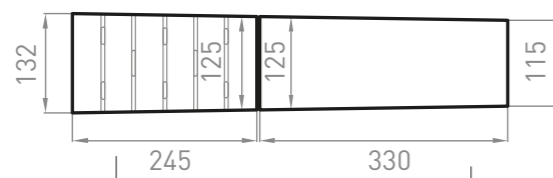

**CRETA CURVE EDGE**  
BORDE CURVO CRETA

**RJ67 RI01 GRATE**  
REJILLA RJ67 RI01

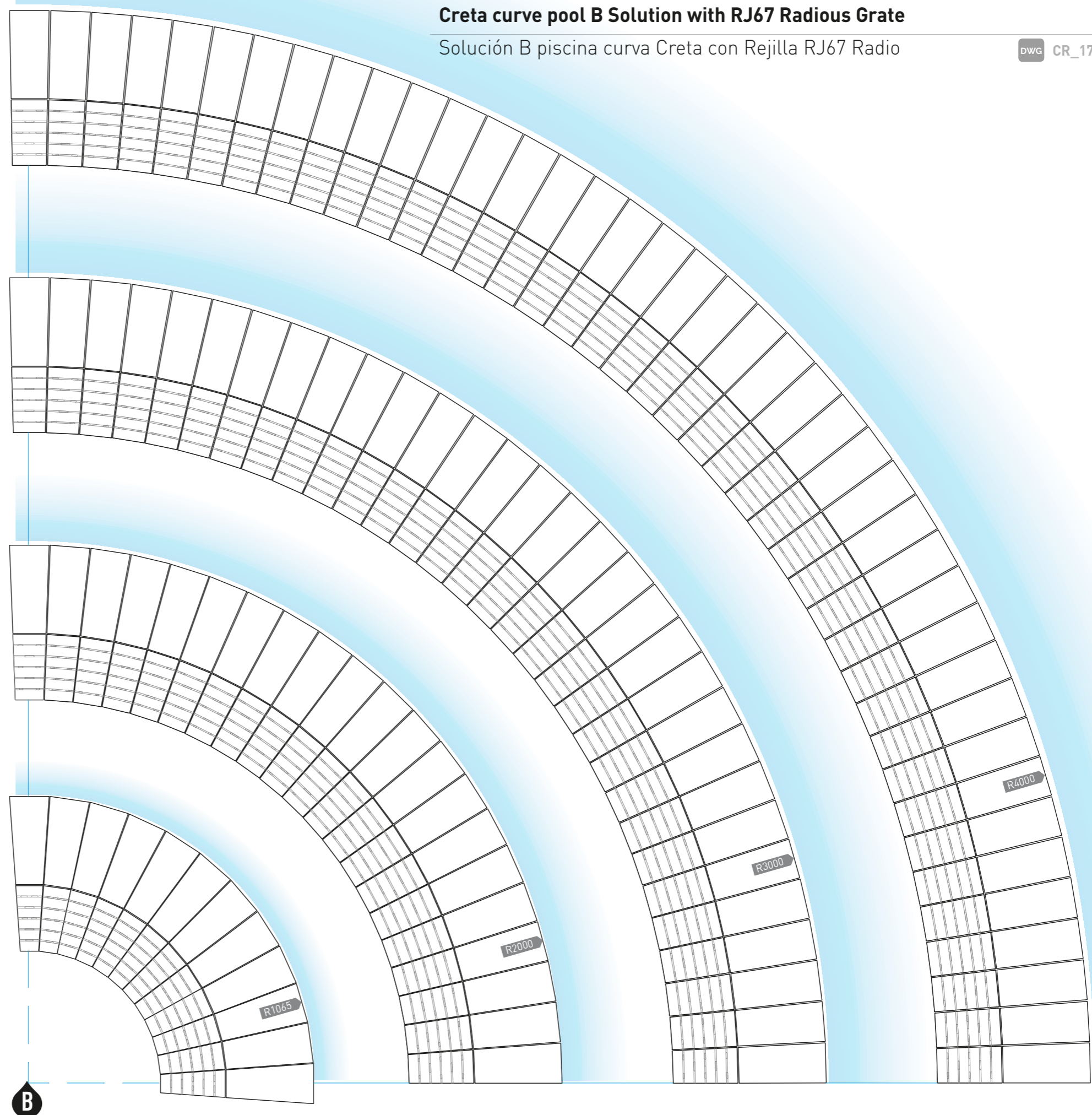



## MAUI



**OVERFLOWING SYSTEM**  
SISTEMA DESBORDANTE

Maui System + RJ67 Grate System  
Color: Stromboli Light

# MAUI OVERFLOWING COPING SYSTEM

## SISTEMA DE CORONACIÓN DESBORDANTE



**MAUI EDGE**  
BORDE MAUI  
Ref. BPMA 0000 33x50 **(M-746) pz**  
MONOBLOCK

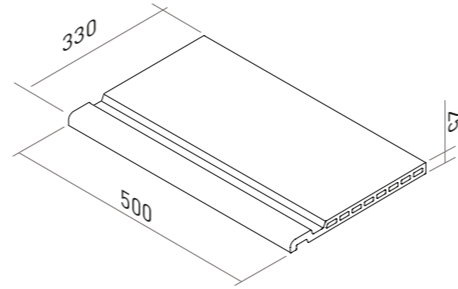

**CERAMIC DRAIN GRATE**  
REJILLA DE DRENAJE CERÁMICA  
Ref. RJ67 0000 25x50 **(M-780) pz**  
MONOBLOCK

**ANTISHOCK**



Component: Grate Rubber included  
Componente: Goma p/Rejilla incluida  
Art. 7966 **(M-771) ml**

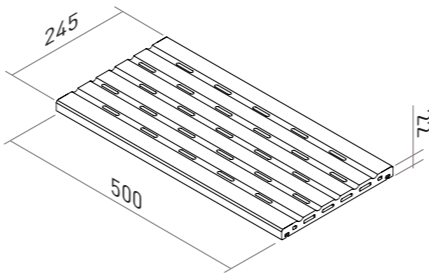

Breaking Load  
Fuerza de rotura **>3500N**  
EN ISO 10545-4

Drain  
Desagüe **> 19.7 m³/hora**



**GRATE SUPPORT**  
SOPORTE P/REJILLA  
Ref. BSCA 0000 18x50 **(M-729) pz**  
MONOBLOCK

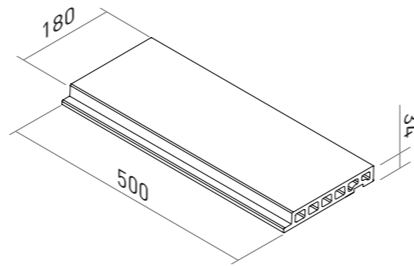

### OVERFLOWING SYSTEM DETAIL

### DETALLE SISTEMA DESBORDANTE

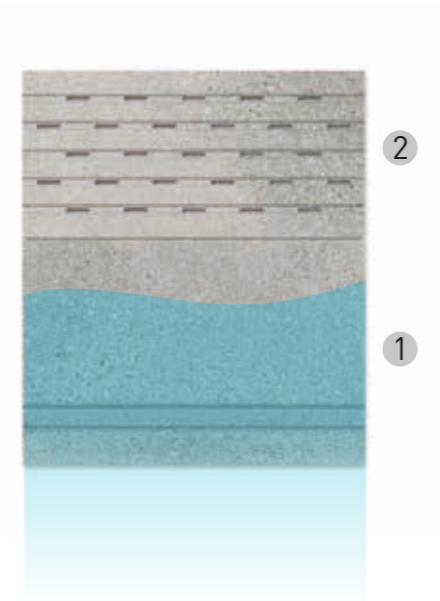

- 1\_ MAUI EDGE  
BORDE MAUI
- 2\_ CERAMIC GRATE RJ67  
REJILLA CERÁMICA RJ67
- 3\_ GRATE SUPPORT  
SOPORTE REJILLA

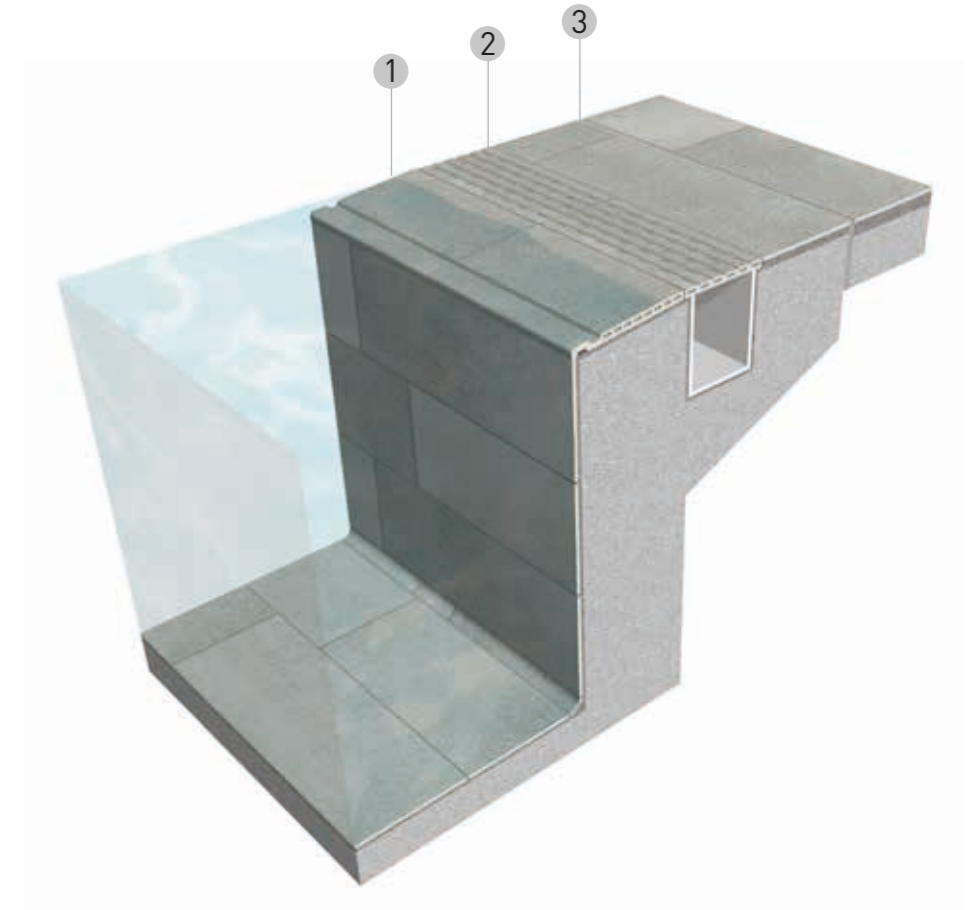

#### TECHNICAL INFORMATION

#### INFORMACIÓN TÉCNICA

**MONOBLOCK** ONE PIECE WITHOUT GLUED  
UNA PIEZA, SIN PEGADO



UNE ENV 12633  
**Clase 3**



DIN 51130  
**R11**



DIN 51097  
**Clase C**



EN ISO 10545-12  
**✓**



EN ISO 10545-13  
**GA / GLA / GHA**



**NOISELESS**  
SILENCIOSO



**LONG LIFE**  
LARGA VIDA



**EASY**  
FÁCIL



Rainforest Blanco



Rainforest Musgo



Stromboli Light



Stromboli Cream



Stromboli Silver



Sea Rock Caramel



**CORNER SOLUTION**  
SOLUCIÓN ESQUINA

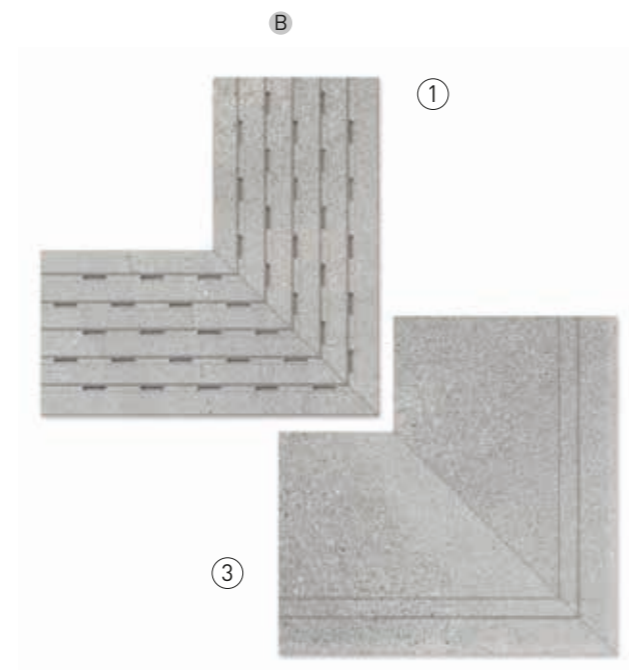

**CERAMIC GRATE CORNER PACK**  
PACK ESQUINA REJILLA CERÁMICA  
① Ref. RJ67 E000 25x50 **(M-781) 2pz**

**MAUI EDGE CORNER PACK**  
PACK ESQUINA BORDE MAUI  
② Ref. BPMA E100 33x50 **(M-748) 2pz**

**MAUI EDGE CORNER PACK**  
PACK ESQUINA BORDE MAUI  
③ Ref. BPCR EE00 33x50 **(M-748) 2pz**

**CURVED SOLUTION**  
SOLUCIÓN CURVA



Special Projects, consult factory. Extra cost Ref. 6624 (M-600) pz  
Proyectos especiales consultar con fábrica. Coste extra Ref. 6624 (M-600) pz

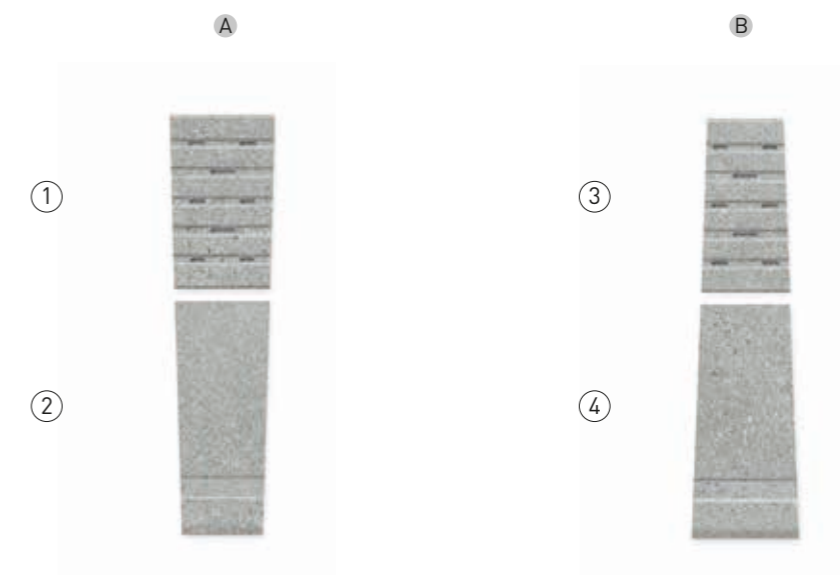

**CURVE CERAMIC GRATE**  
REJILLA CERÁMICA CURVA  
① Ref. RJ67 R100 **(M-782) 2pzs**  
③ Ref. RJ67 RE00 **(M-782) 2pzs**

**MAUI CURVE EDGE**  
BORDE CURVO MAUI  
② Ref. BPMA R100 33x50 **(M-775) pz**  
④ Ref. BPMA RE00 33x50 **(M-775) pz**

## Straight system pieces with RJ67 Grate

Sistema de piezas en recto con Rejilla RJ67

DWG MA\_170701

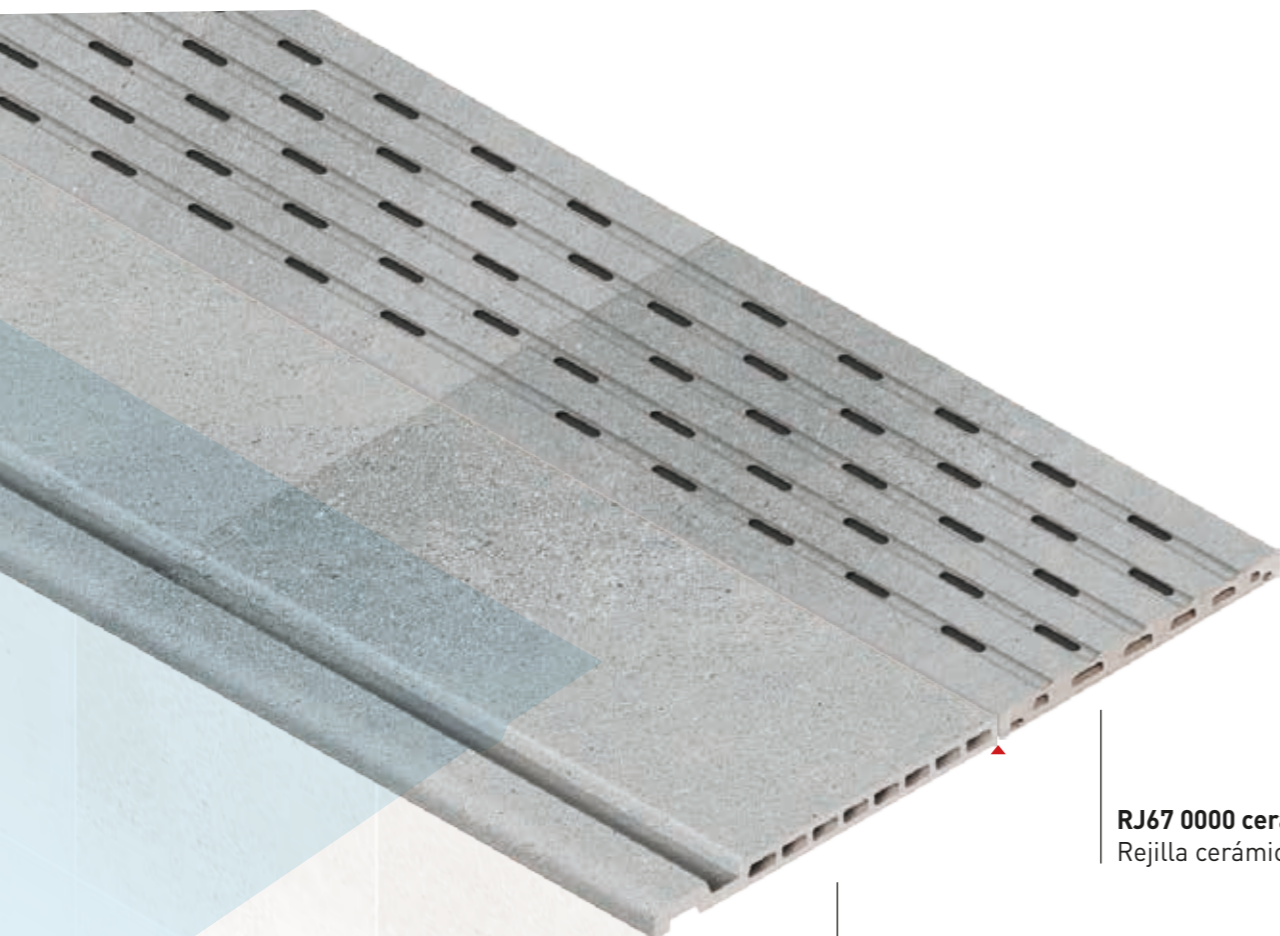

**RJ67 0000 ceramic grate**  
Rejilla cerámica RJ67 0000

**Maui System**  
Sistema Maui

**Ceramic grate**  
Rejilla cerámica  
Ref. RJ67 0000 25x50

**Maui pool edge**  
Borde piscina Maui  
Ref. BPMA 0000 33x50

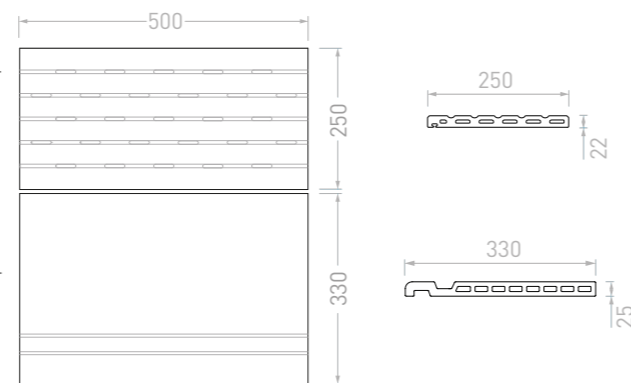

## Straight system pieces with RJ70 Grate

Sistema de piezas en recto con Rejilla RJ70

DWG MA\_170701

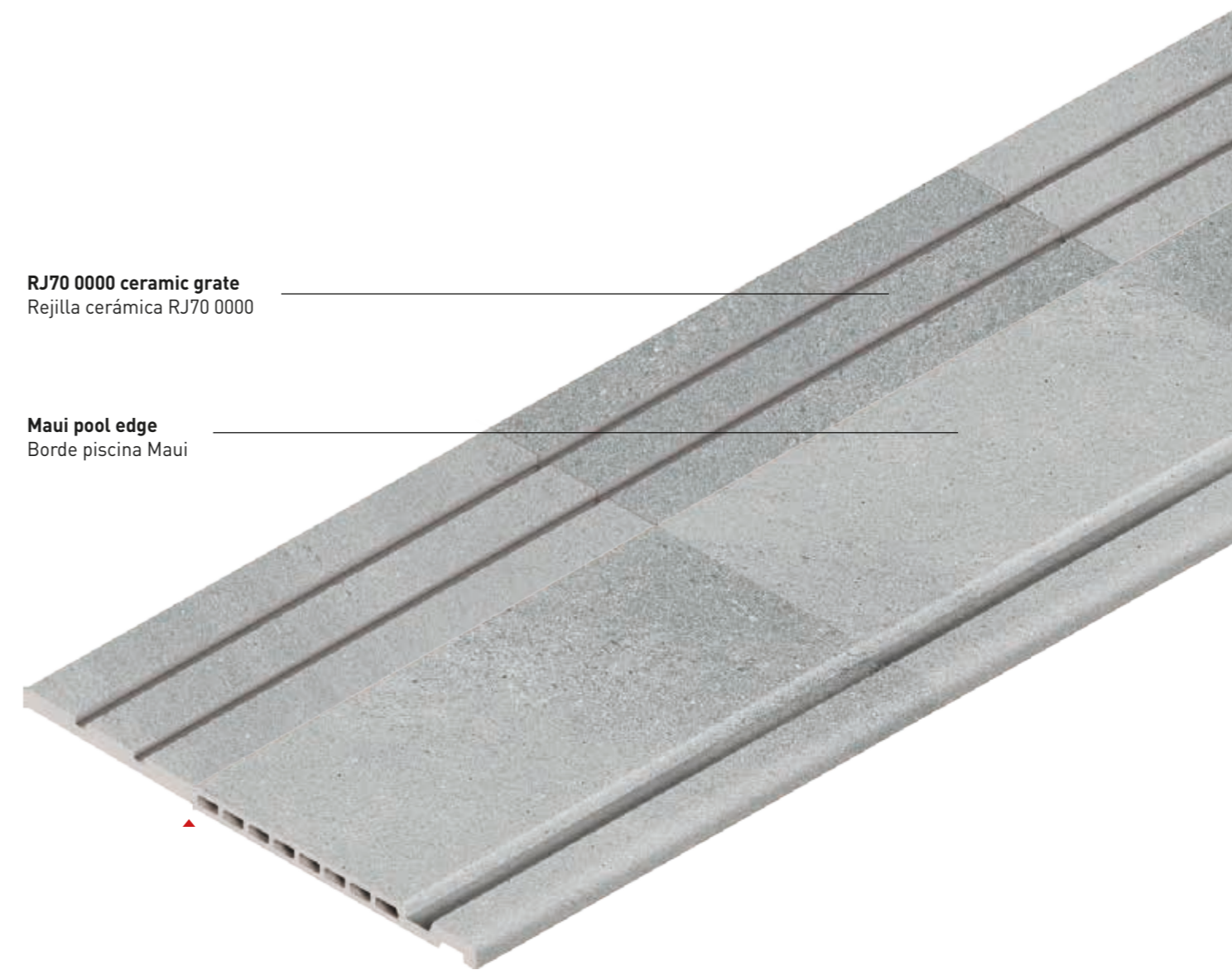

**RJ70 0000 ceramic grate**  
Rejilla cerámica RJ70 0000

**Maui pool edge**  
Borde piscina Maui

**Ceramic grate**  
Rejilla cerámica  
Ref. RJ70 0000 20x50

**Maui pool edge**  
Borde piscina Maui  
Ref. BPMA 0000 33x50

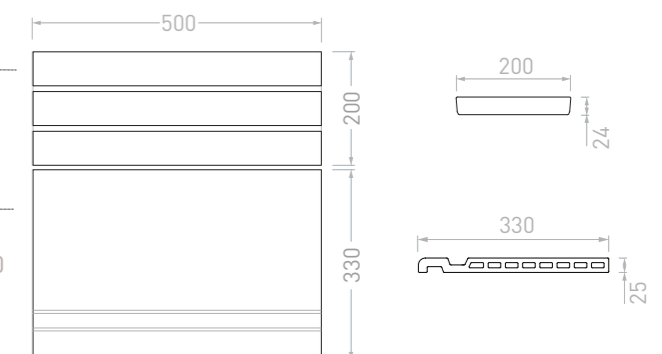



## Maui detail system

Detalle del sistema Maui

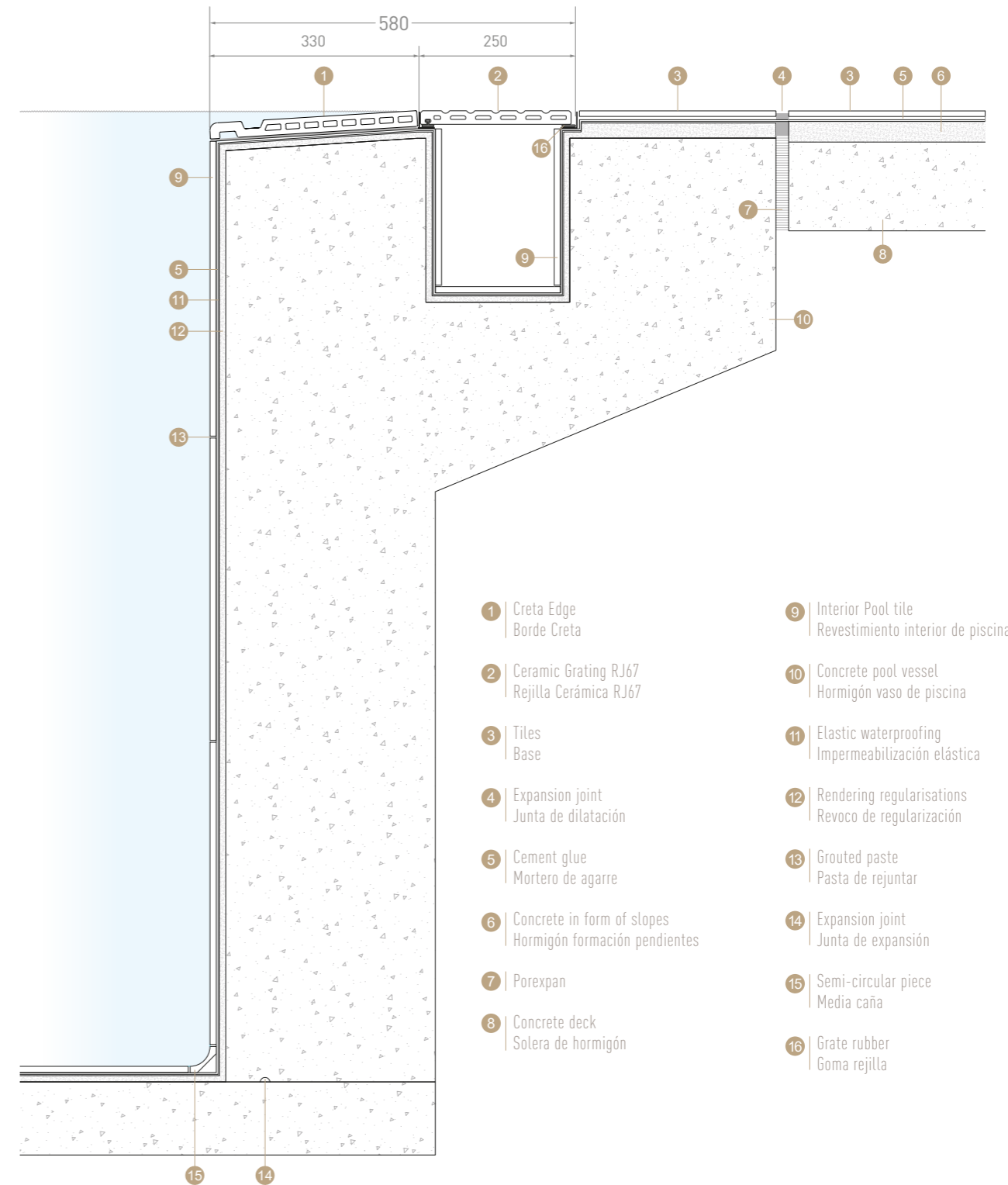

### Corner Solutions with RJ67 Grate system

Soluciones de esquina con el sistema de Rejilla RJ67

DWG MA\_190315

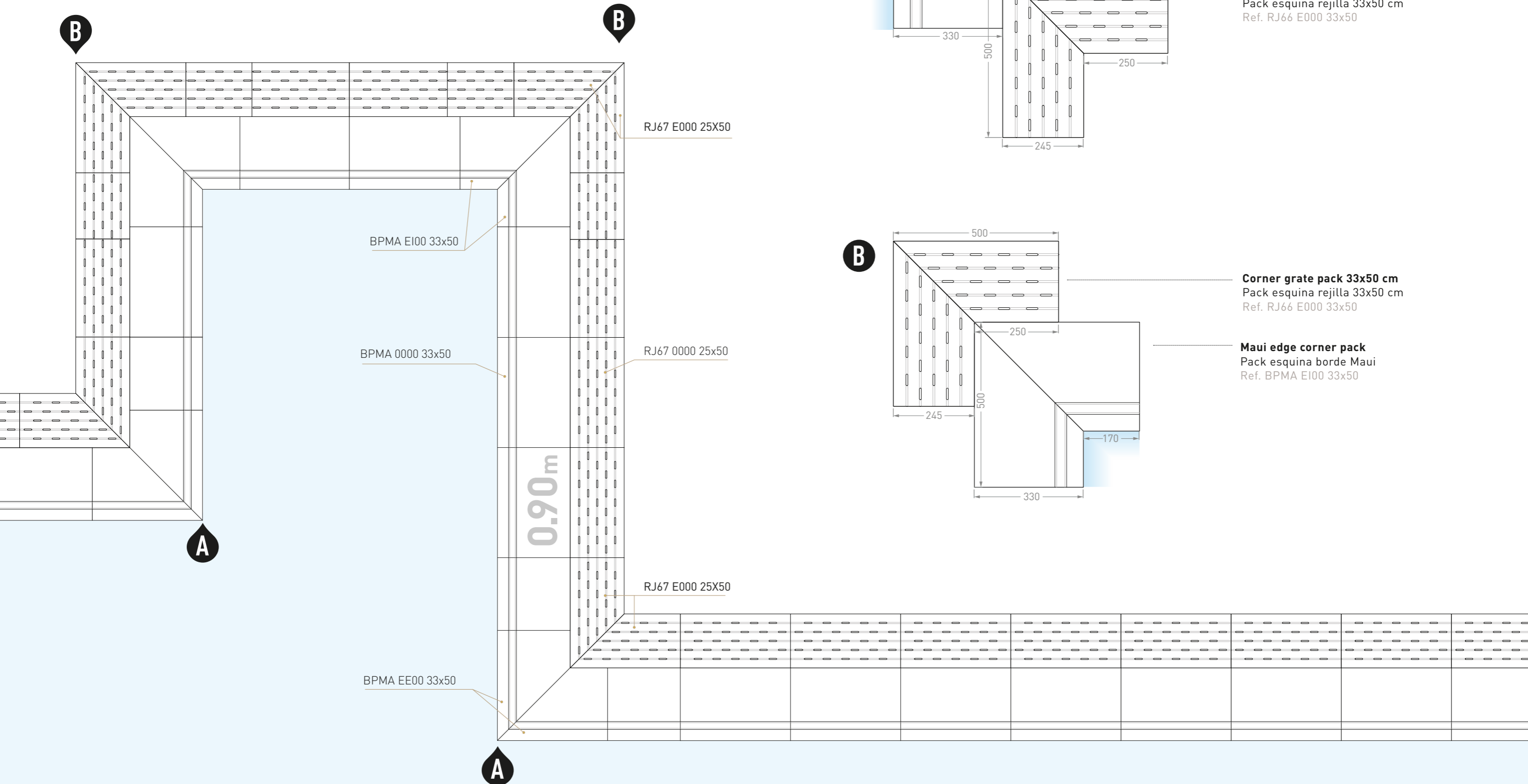

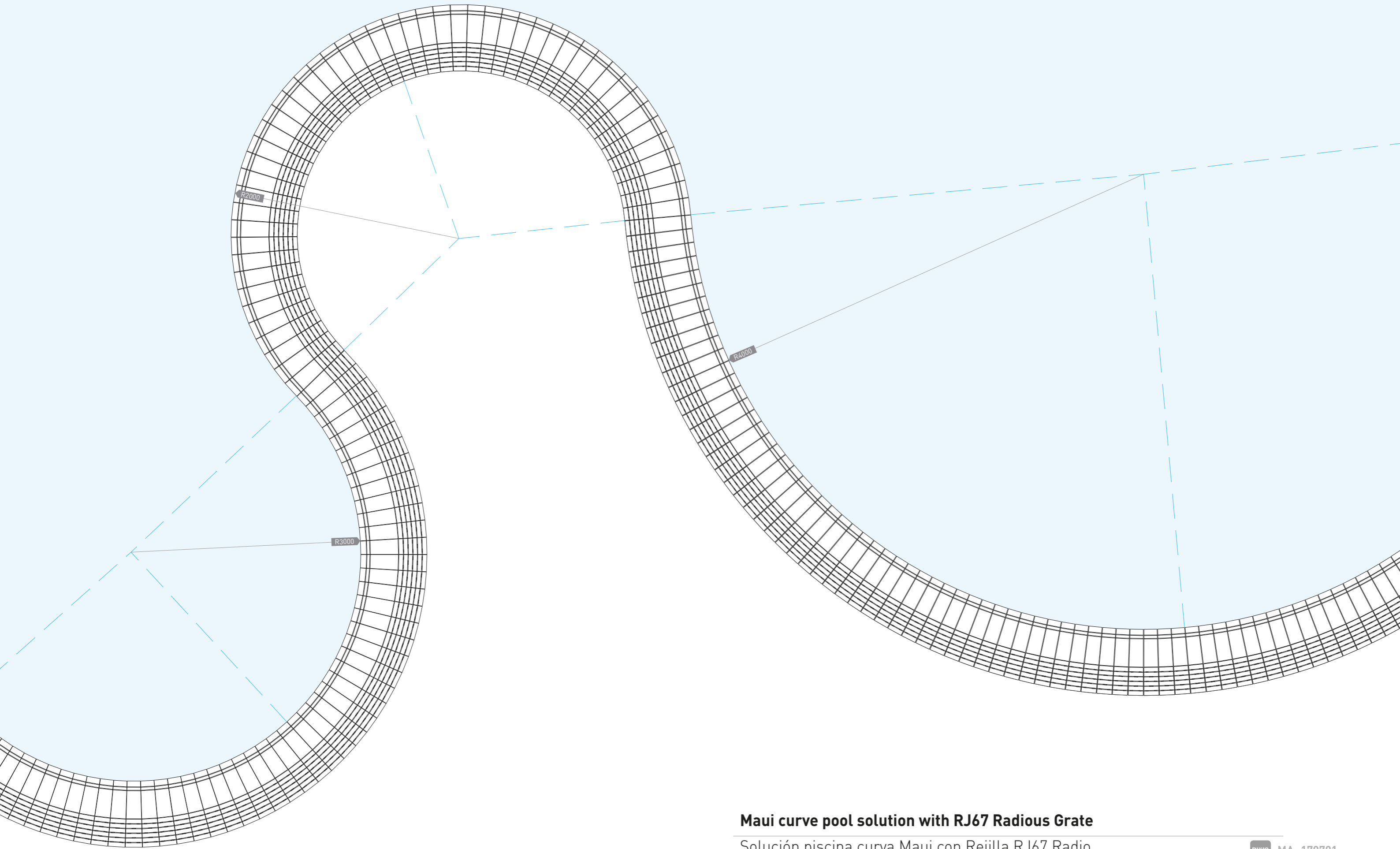

**Maui curve pool solution with RJ67 Radius Grate**

Solución piscina curva Maui con Rejilla RJ67 Radio

DWG MA\_170701

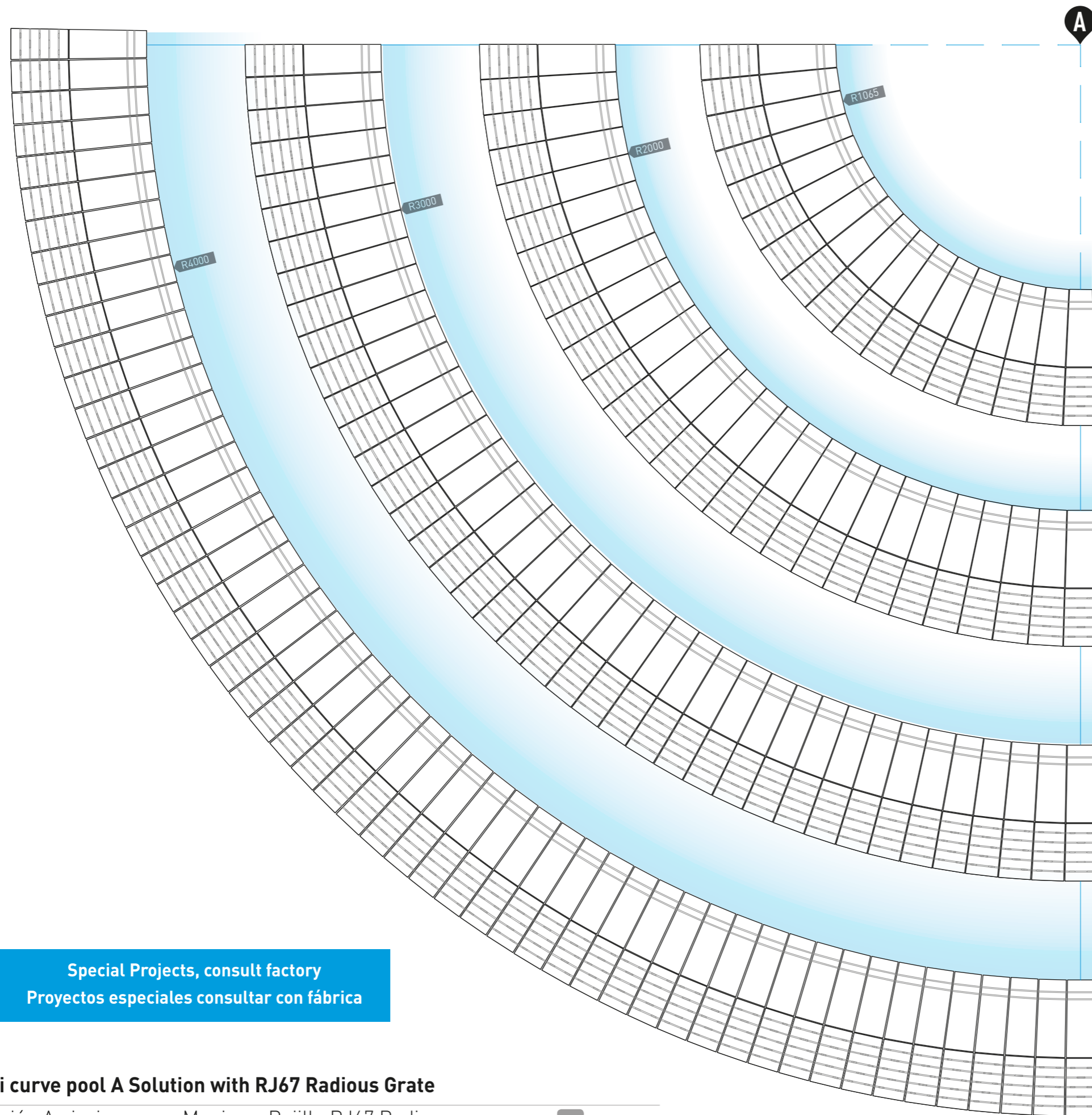

RJ67 RI01 GRATE  
REJILLA RJ67 RI01

MAUI CURVE EDGE  
BORDE CURVO MAUI

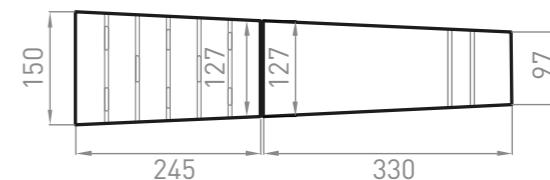

RADIO 1.06 m

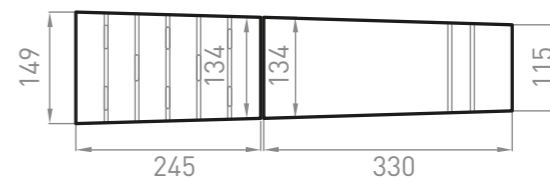

RADIO 2.00 m

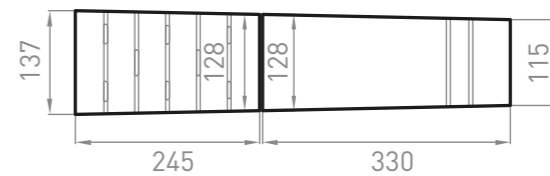

RADIO 3.00 m

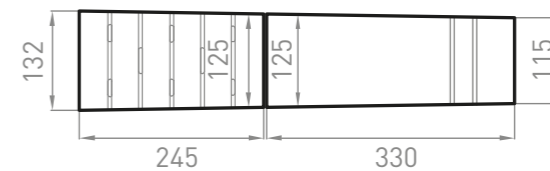

RADIO 4.00 m

Special Projects, consult factory  
Proyectos especiales consultar con fábrica

**Maui curve pool A Solution with RJ67 Radius Grate**

Solución A piscina curva Maui con Rejilla RJ67 Radio

DWG CR\_170701

**Maui curve pool B Solution with RJ67 Radius Grate**

Solución B piscina curva Maui con Rejilla RJ67 Radio

DWG CR\_170701

RADIO 4.00 m

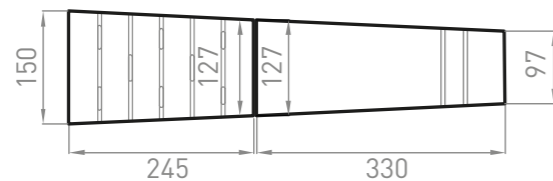

RADIO 3.00 m

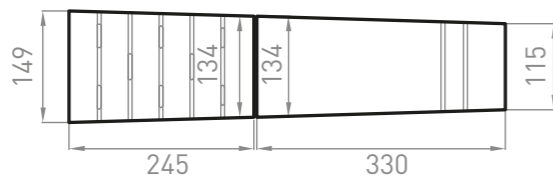

RADIO 2.00 m

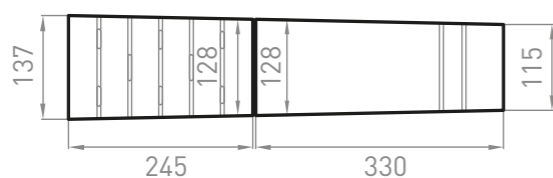

RADIO 1.06 m

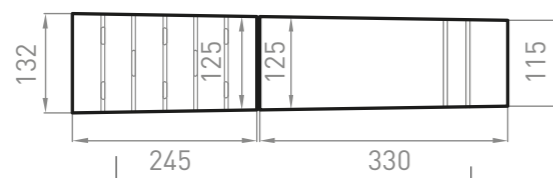

**MAUI CURVE EDGE**  
BORDE CURVO CRETA

**RJ67 RI01 GRATE**  
REJILLA RJ67 RI01

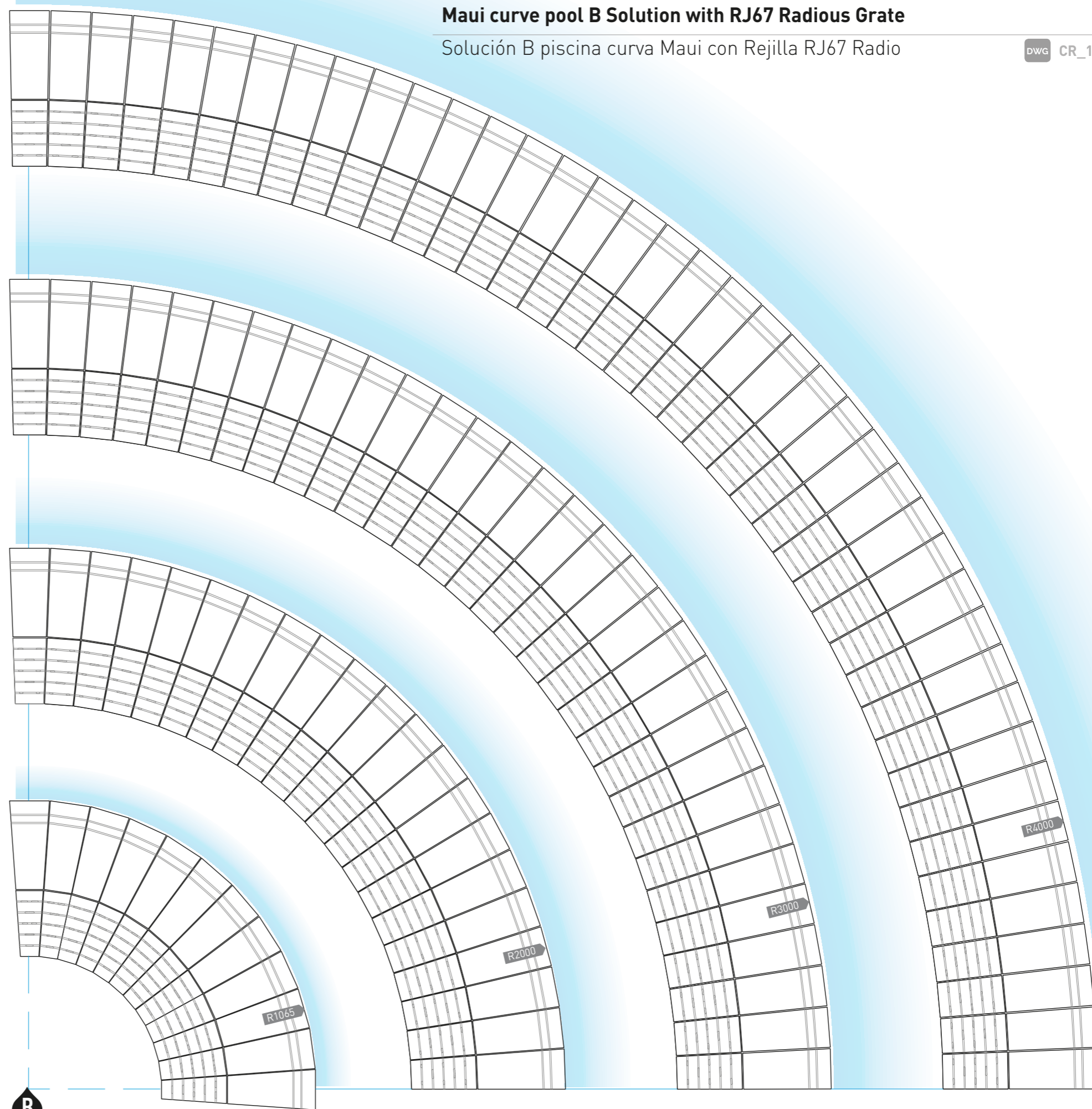



## MIKONOS



**SKIMMER SYSTEM**  
SISTEMA SKIMMER

Mikonos System  
Color: Stromboli Light



# MIKONOS SKIMMER COPING SYSTEM

## SISTEMA DE CORONACIÓN SKIMMER

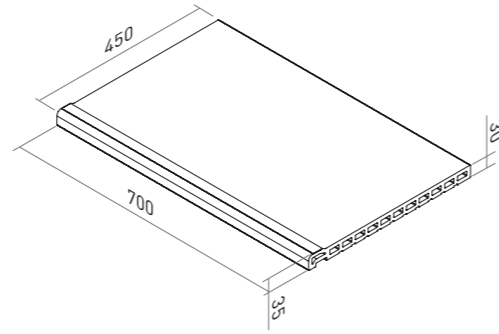

**R12** Super antislip  
Súper antideslizante

**-30%** of thermal feeling  
de sensación térmica



**MIKONOS EDGE**  
BORDE MIKONOS  
Ref. BPMI 0000 E2C 45x70 **(M-517)** pz  
**MONOBLOCK**



Special pieces for skimmer  
Piezas especiales para skimmer



**COVER FOR SKIMMER HOLE**  
TAPA PARA AGUJERO SKIMMER  
Ref. BPMI SKTP **(M-530)** pz  
**MONOBLOCK**

**SPECIAL PIECE WITH HOLE FOR SKIMMER**  
PIEZA ESPECIAL CON AGUJERO PARA SKIMMER  
Ref. BPMI SK00 E2C 45x70 **(M-530)** pz  
**MONOBLOCK**



STROMBOLI\_light

### OVERFLOWING SYSTEM DETAIL

#### DETALLE SISTEMA DESBORDANTE

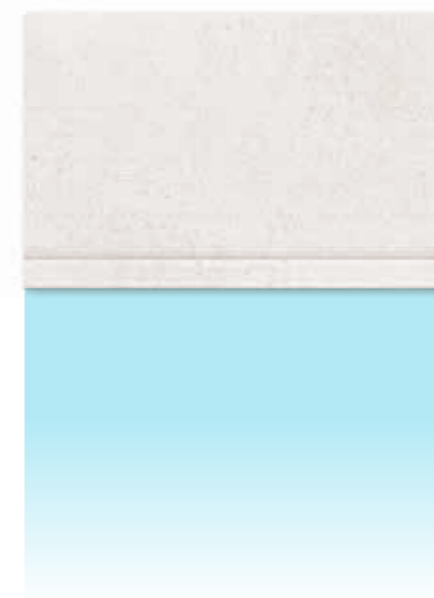

1\_ MIKONOS EDGE  
BORDE MIKONOS  
2\_ TILES  
BASE

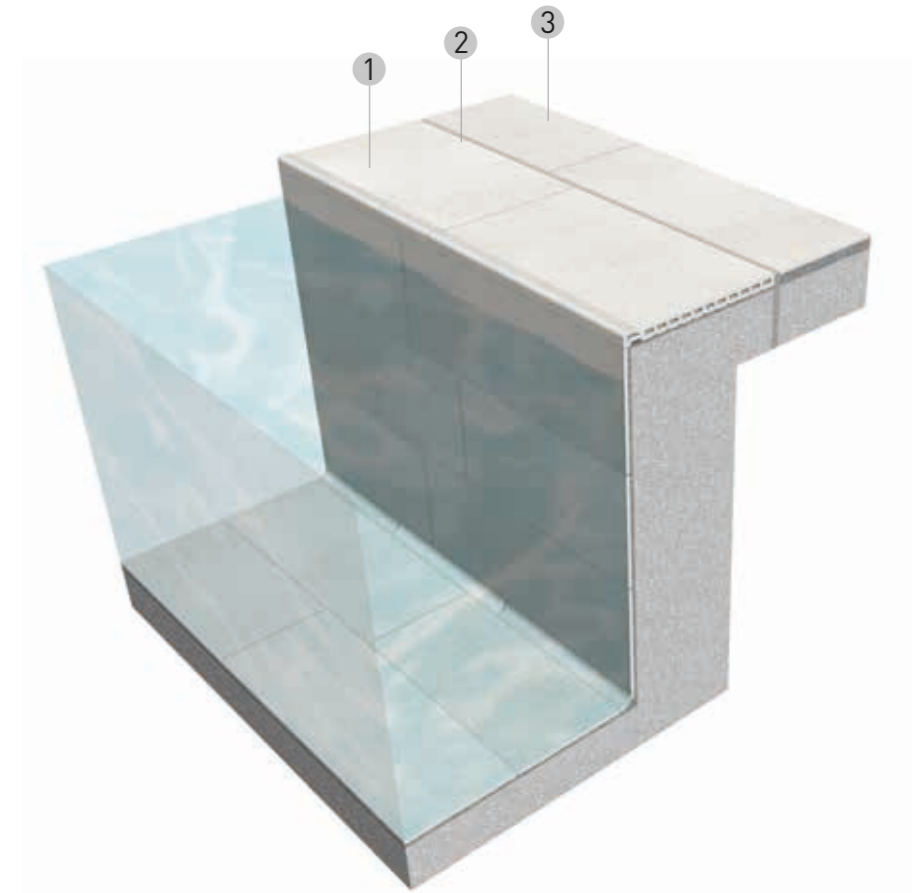

#### TECHNICAL INFORMATION

#### INFORMACIÓN TÉCNICA

**MONOBLOCK** ONE PIECE WITHOUT GLUED  
UNA PIEZA, SIN PEGADO

UNE ENV 12633  
**Clase 3**

DIN 51130  
**R12**

DIN 51097  
**Clase C**

EN ISO 10545-12  
**✓**

EN ISO 10545-13  
**GA / GLA / GHA**

**NOISELESS**  
SILENCIOSO

**LONG LIFE**  
LARGA VIDA

**EASY**  
FÁCIL



Rainforest Blanco



Rainforest Musgo



Stromboli Light



Stromboli Cream



Stromboli Silver



Sea Rock Caramel

**CORNER SOLUTION**  
SOLUCIÓN ESQUINA

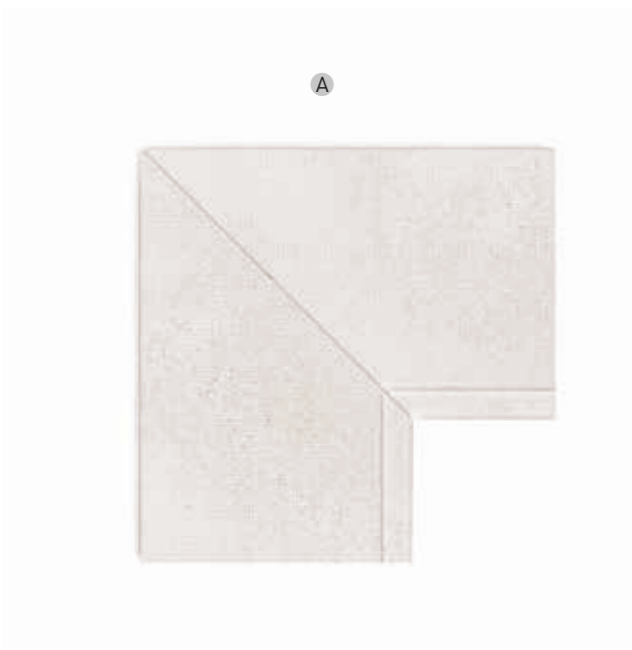

**MIKONOS EDGE CORNER PACK**  
PACK ESQUINA BORDE MIKONOS  
Ref. BPMI EI00 E2C 45x70 **(M-567) 2pz**

**MIKONOS EDGE CORNER PACK**  
PACK ESQUINA BORDE MIKONOS  
Ref. BPMI EE00 E2C 45x70 **(M-567) 2pz**

**CURVED SOLUTION**  
SOLUCIÓN CURVA

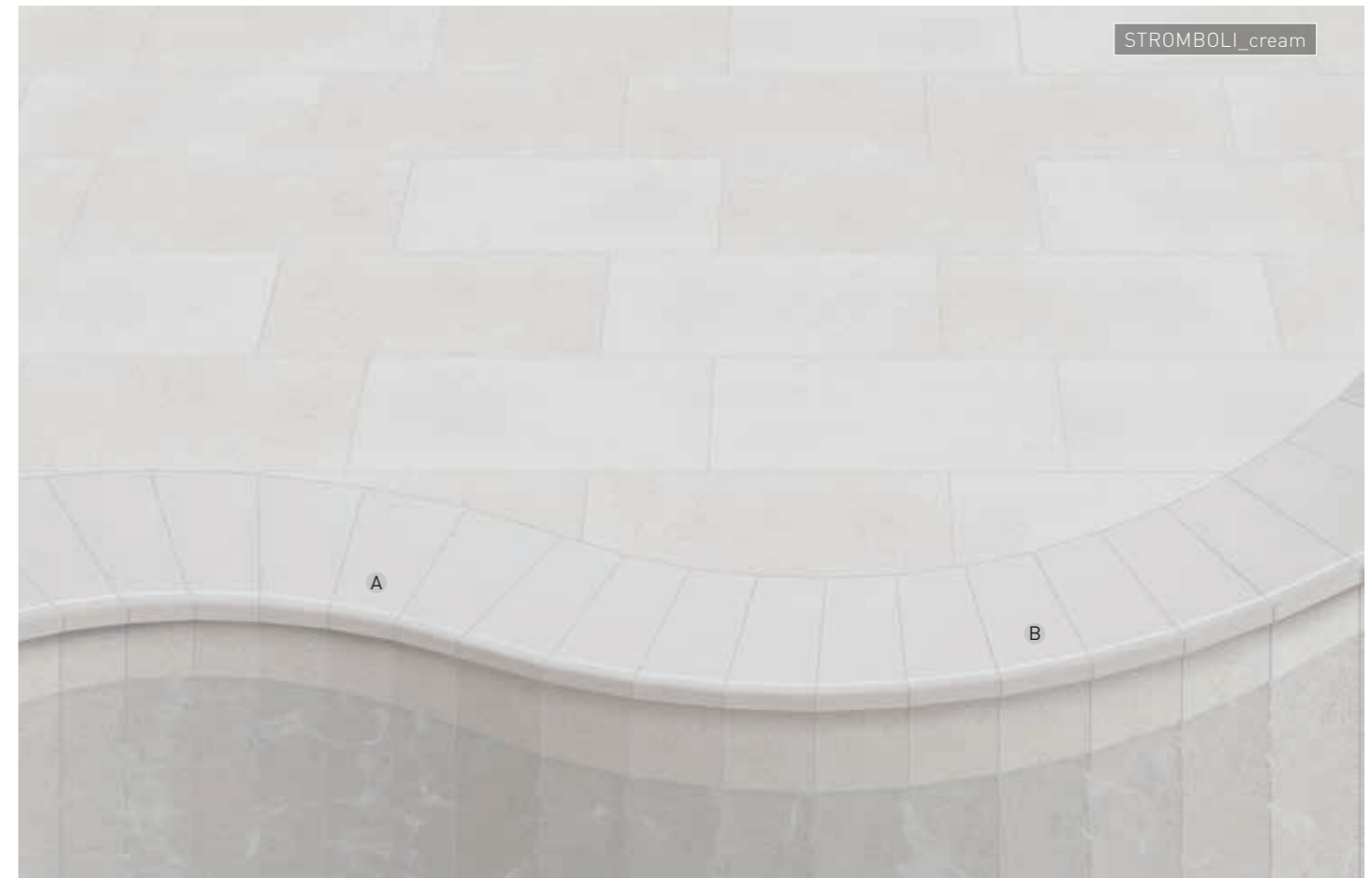

Special Projects, consult factory. Extra cost Ref. 6624 **(M-600) pz**  
Proyectos especiales consultar con fábrica. Coste extra Ref. 6624 **(M-600) pz**



**MIKONOS CURVE EDGE**  
BORDE CURVO MIKONOS  
Ref. BPMI RI00 E2C 45x- **(M-737) pz**

**MIKONOS CURVE EDGE**  
BORDE CURVO MIKONOS  
Ref. BPMI RI00 E2C 45x- **(M-737) pz**

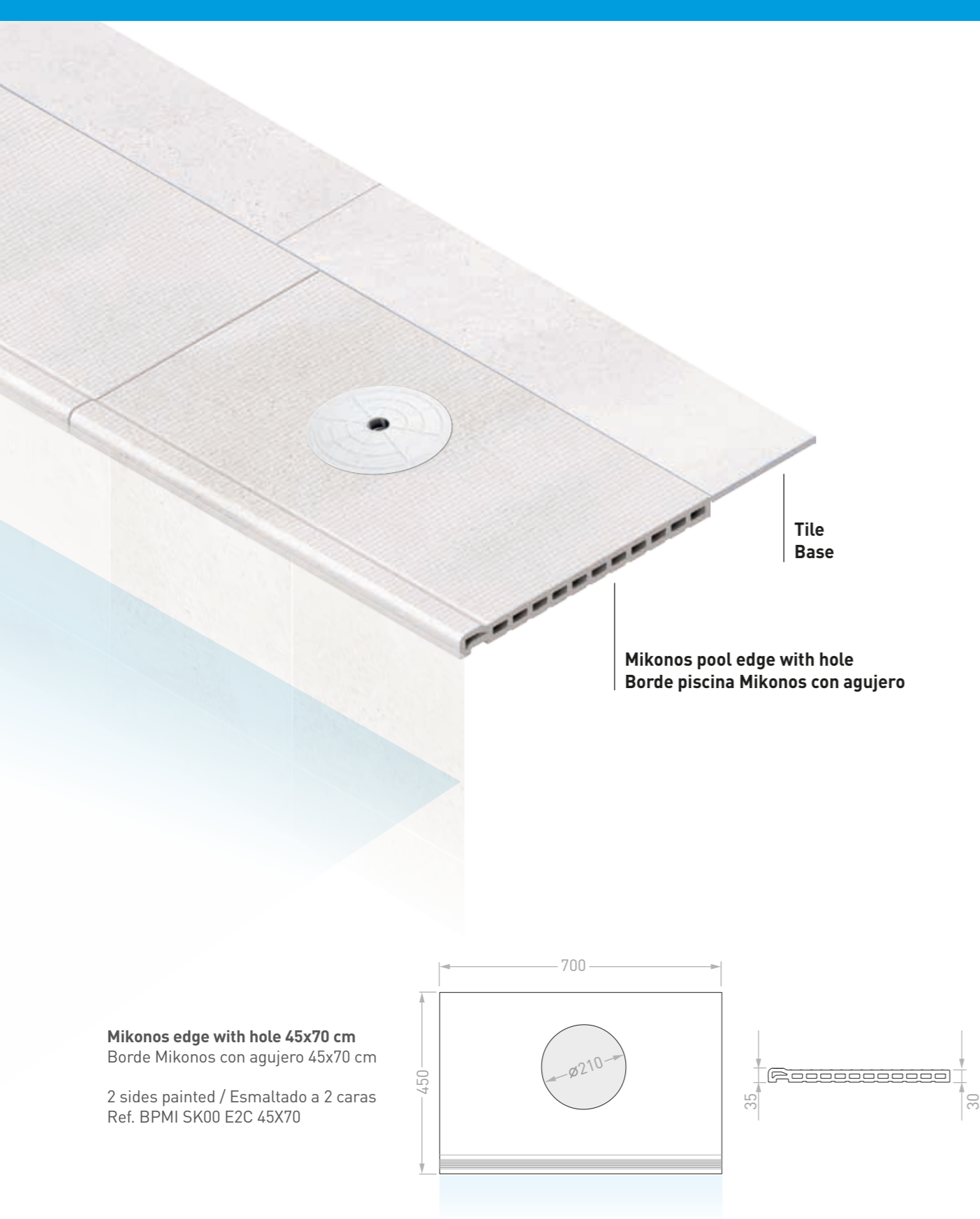

▲ L profile 25x25 for pieces with out special grate support. Mounting information page 21  
Perfil en L 25x25 para piezas sin soporte especial para rejilla. Información acerca del montaje en la página 21.

### Special piece with hole for skimmer

Pieza especial para skimmer

DWG MI\_160517

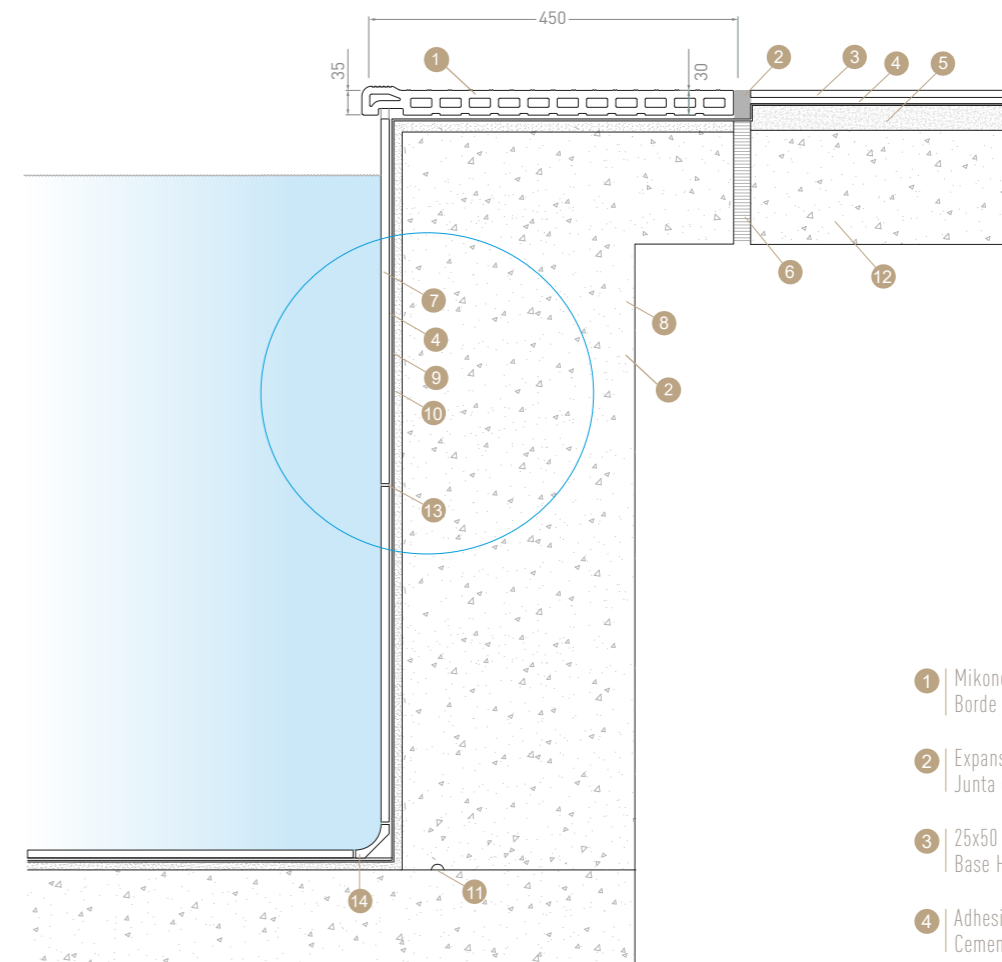

- 1 Mikonos Edge  
Borde Mikonos
- 2 Expansion joint  
Junta de dilatación
- 3 25x50 Hawaii tile  
Base Hawaii 25x50
- 4 Adhesive glue  
Cemento cola
- 5 Concrete in form of slopes  
Hormigón formación pendientes
- 6 Porexpan
- 7 Interior Pool tile  
Revestimiento interior de piscina
- 8 Concrete pool vessel  
Vaso de piscina de hormigón
- 9 Waterproofing  
Impermeabilización
- 10 Rendering regularisations  
Revoco de regularización
- 11 Expansion joint  
Junta de expansión
- 12 Concrete deck  
Solera de hormigón
- 13 Grouted paste  
pasta para rejunta
- 14 Semi-circular piece  
Media caña

### Mikonos detail system

Detalle del sistema Mikonos

DWG MI\_160517

**Mikonos Corner Solutions**

Soluciones de esquina con el sistema Mikonos

DWG MI\_160517

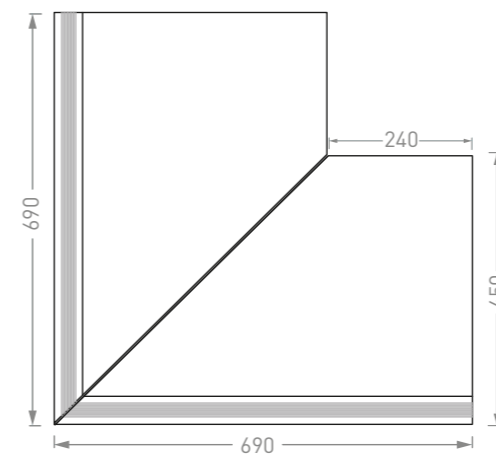
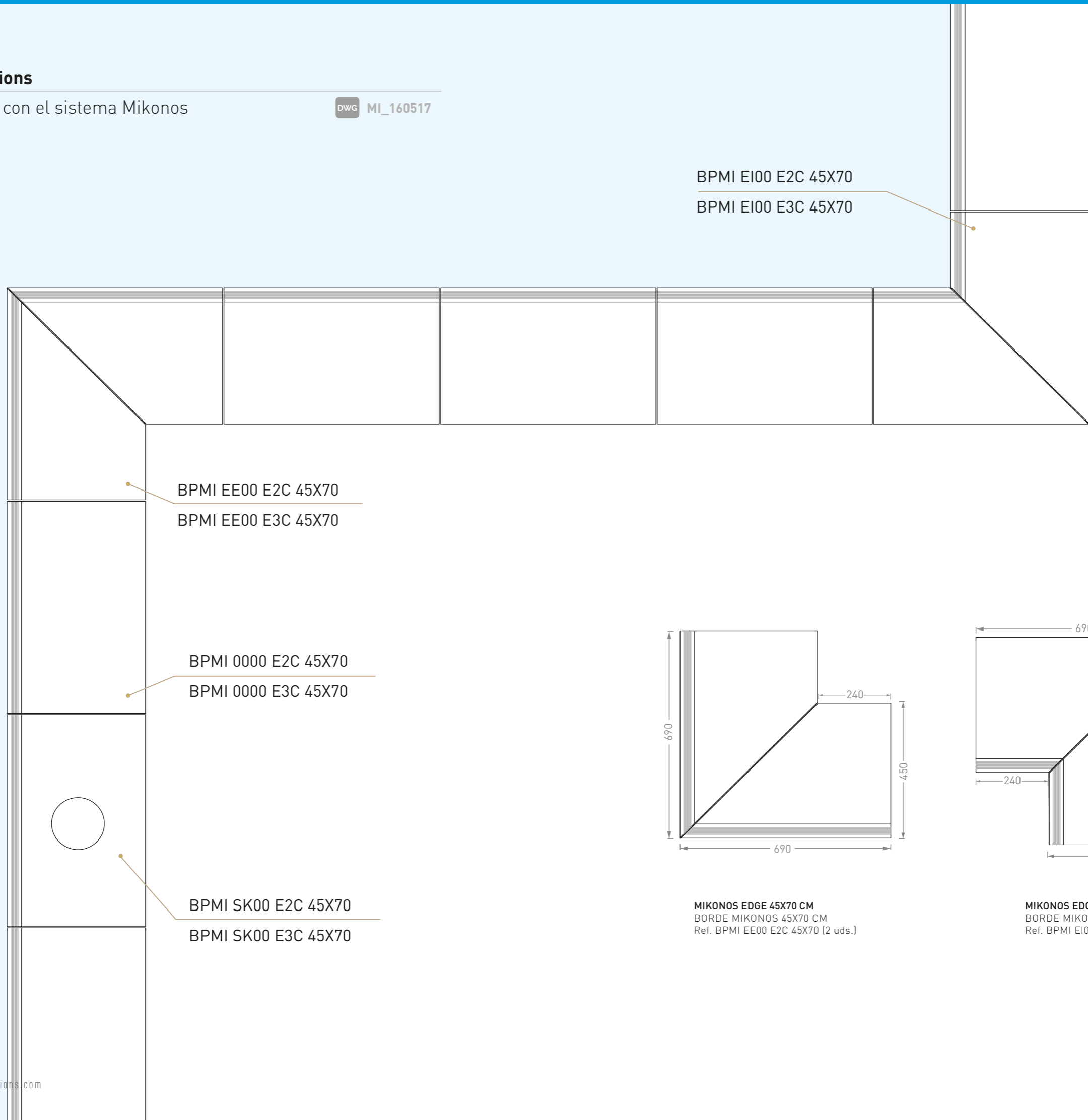

**MIKONOS EDGE 45X70 CM**  
BORDE MIKONOS 45X70 CM  
Ref. BPMI EE00 E2C 45X70 [2 uds.]

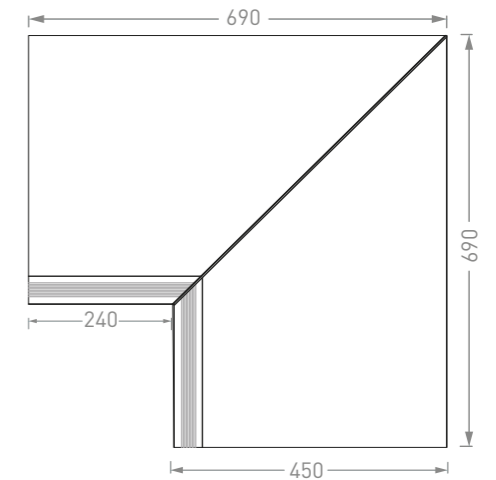

**MIKONOS EDGE 45X70 CM**  
BORDE MIKONOS 45X70 CM  
Ref. BPMI EI00 E2C 45X70 [2 uds.]

### Curve corners samples

Ejemplos esquina curva

DWG MI\_160517

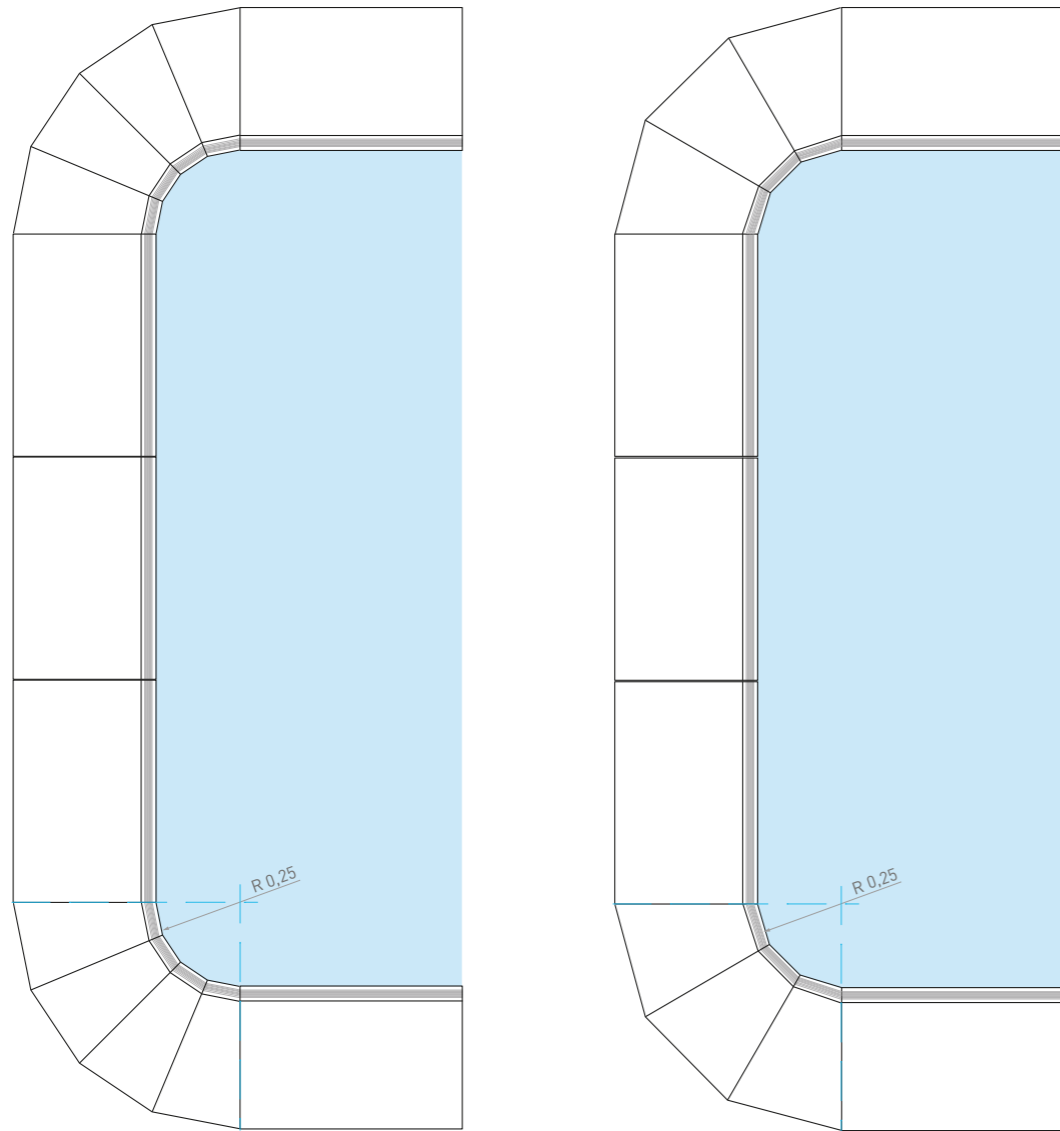

### Curve corner samples with RJ70 and RJ88 Grate

Ejemplos esquina curva con Rejilla RJ70 y RJ88

DWG MI\_160517

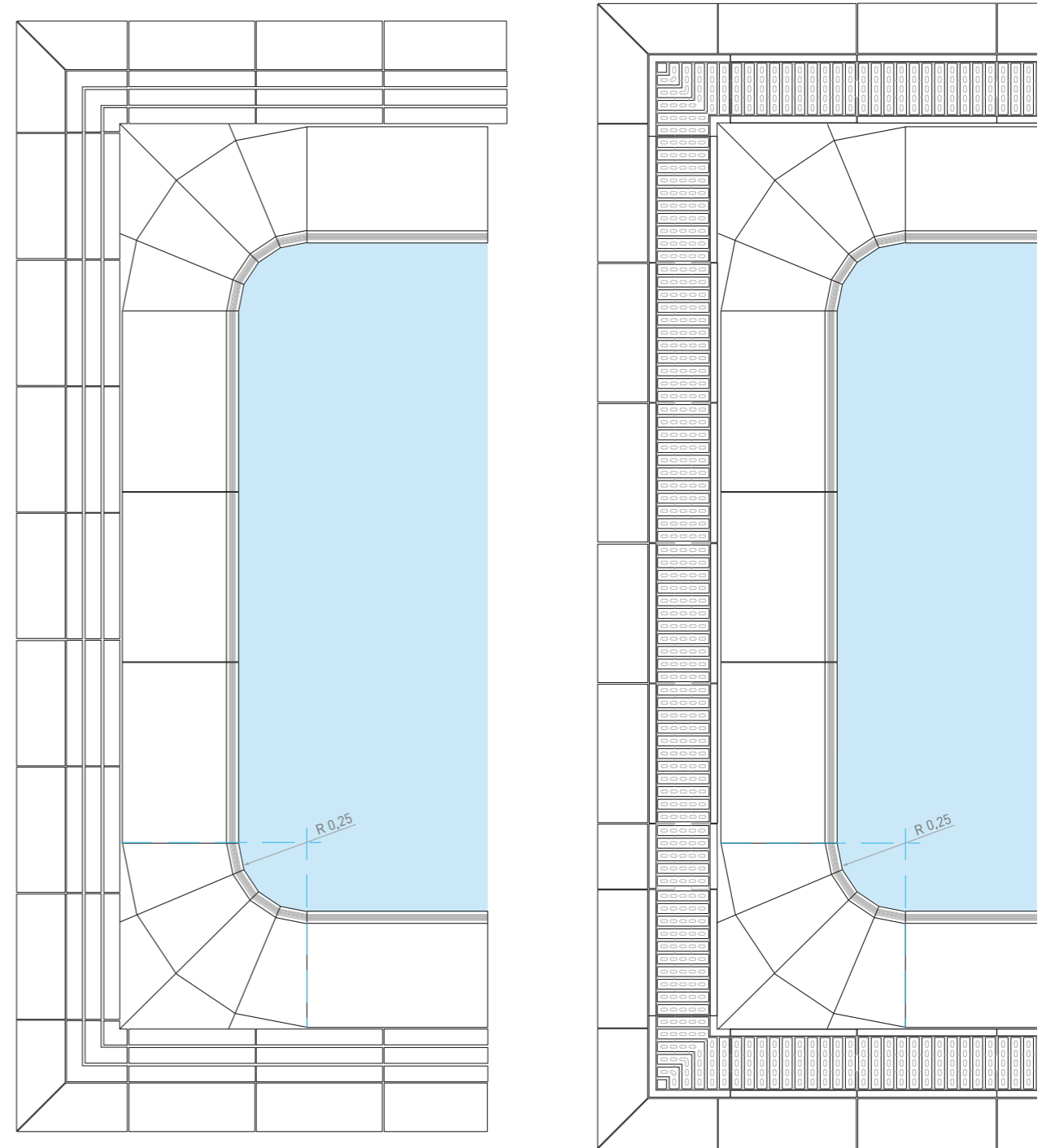

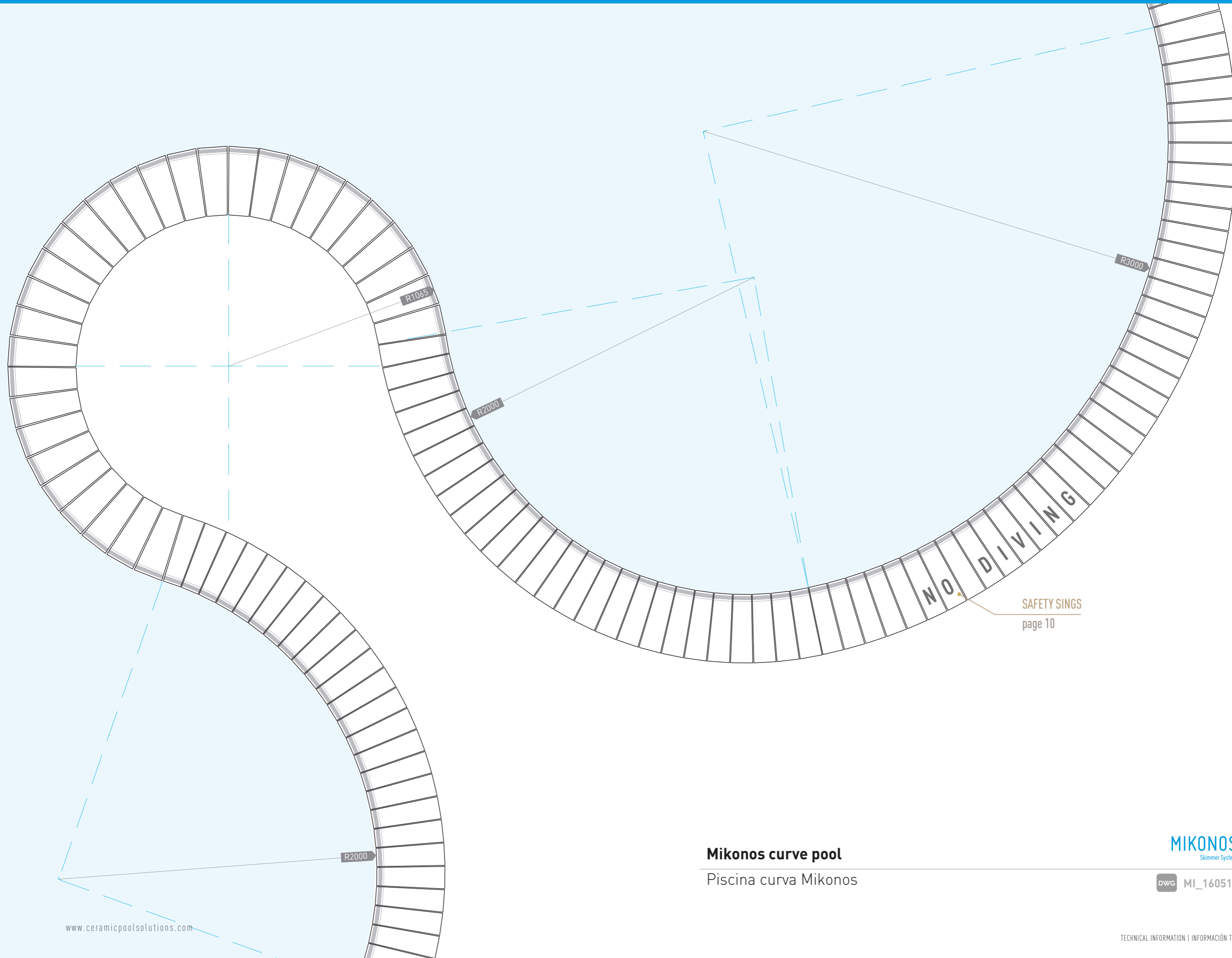

SAFETY SINGS  
page 10

**Mikonos curve pool**  
Piscina curva Mikonos

**MIKONOS**  
Skimmer System

DWG MI\_160517

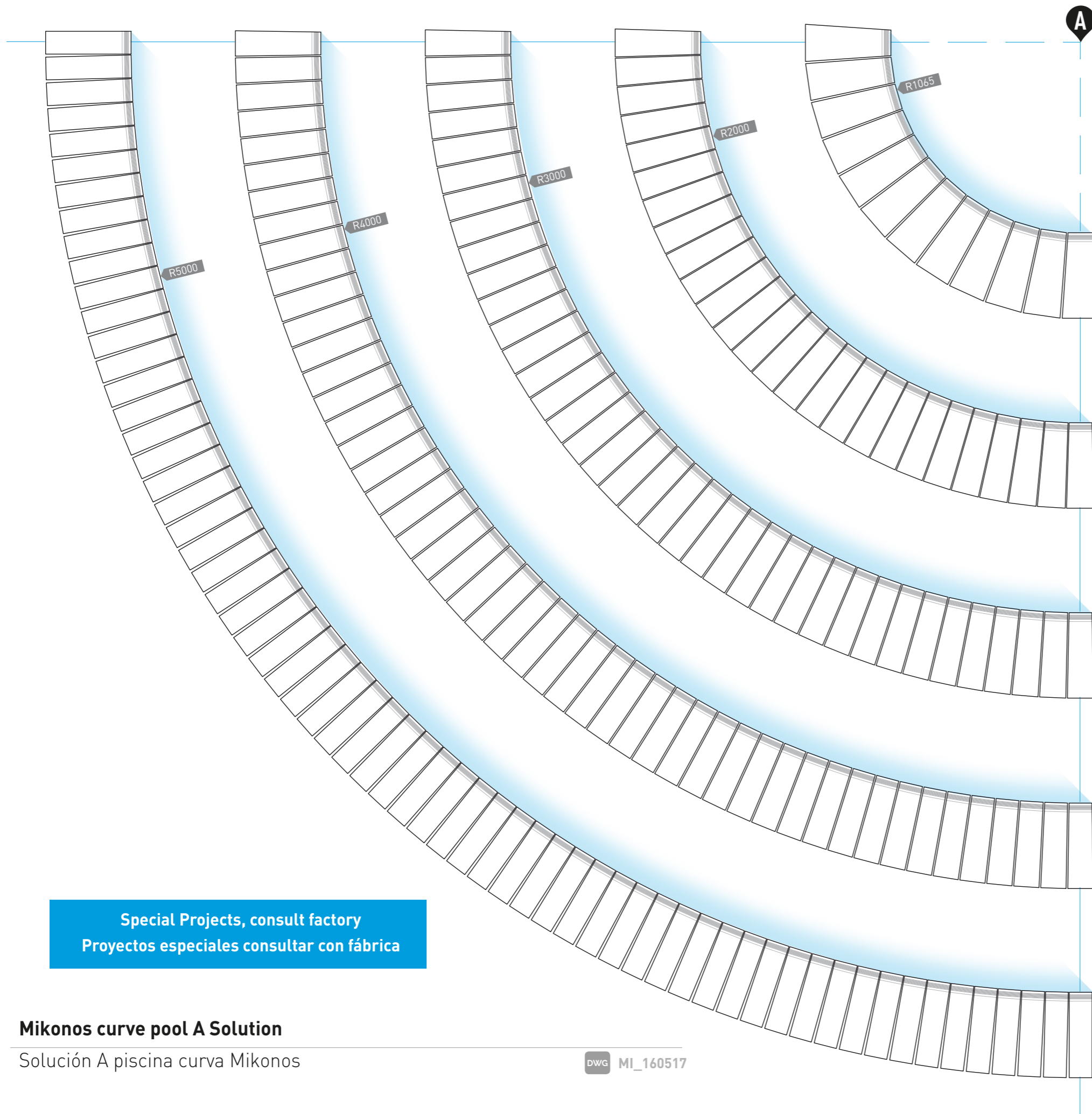

Special Projects, consult factory  
Proyectos especiales consultar con fábrica

**Mikonos curve pool A Solution**

Solución A piscina curva Mikonos

DWG MI\_160517

**MIKONOS CURVED POOL EDGE**  
BORDE CURVO MIKONOS  
Ref. BPMI SPECIAL EI00 E2C 45x

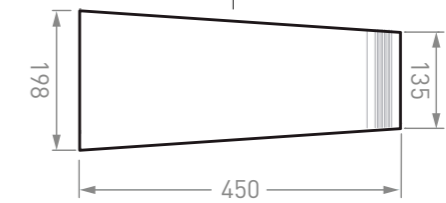

**RADIO 1.06 m**

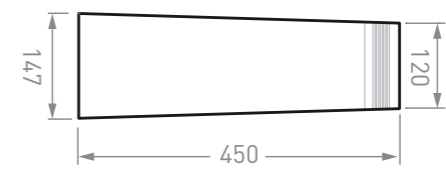

**RADIO 2.00 m**

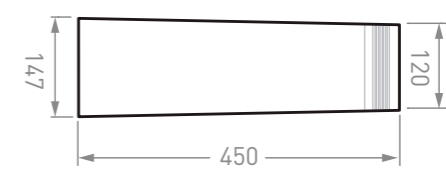

**RADIO 3.00 m**

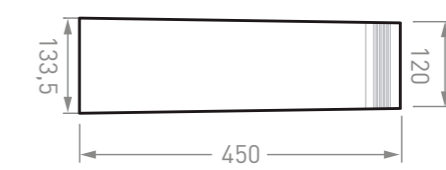

**RADIO 4.00 m**

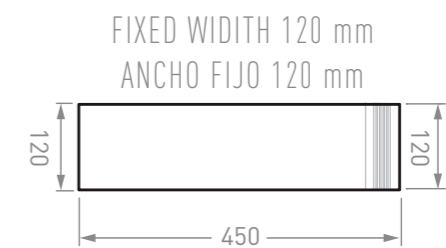

**RADIO 5.00 m**

FIXED WIDTH 120 mm  
ANCHO FIJO 120 mm

**Mikonos curve pool B Solution**

Solución B piscina curva Mikonos

DWG MI\_160517

RADIO 5.00 m

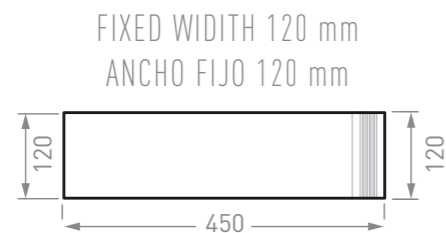

RADIO 4.00 m

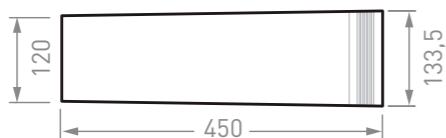

RADIO 3.00 m

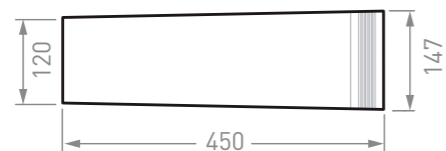

RADIO 2.00 m

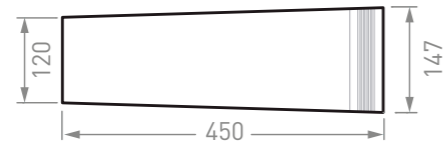

RADIO 1.06 m

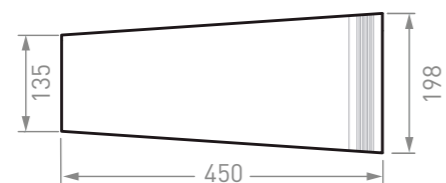

**MIKONOS CURVED POOL EDGE**  
BORDE CURVO MIKONOS

Ref. BPMI SPECIAL EI00 E2C 45x

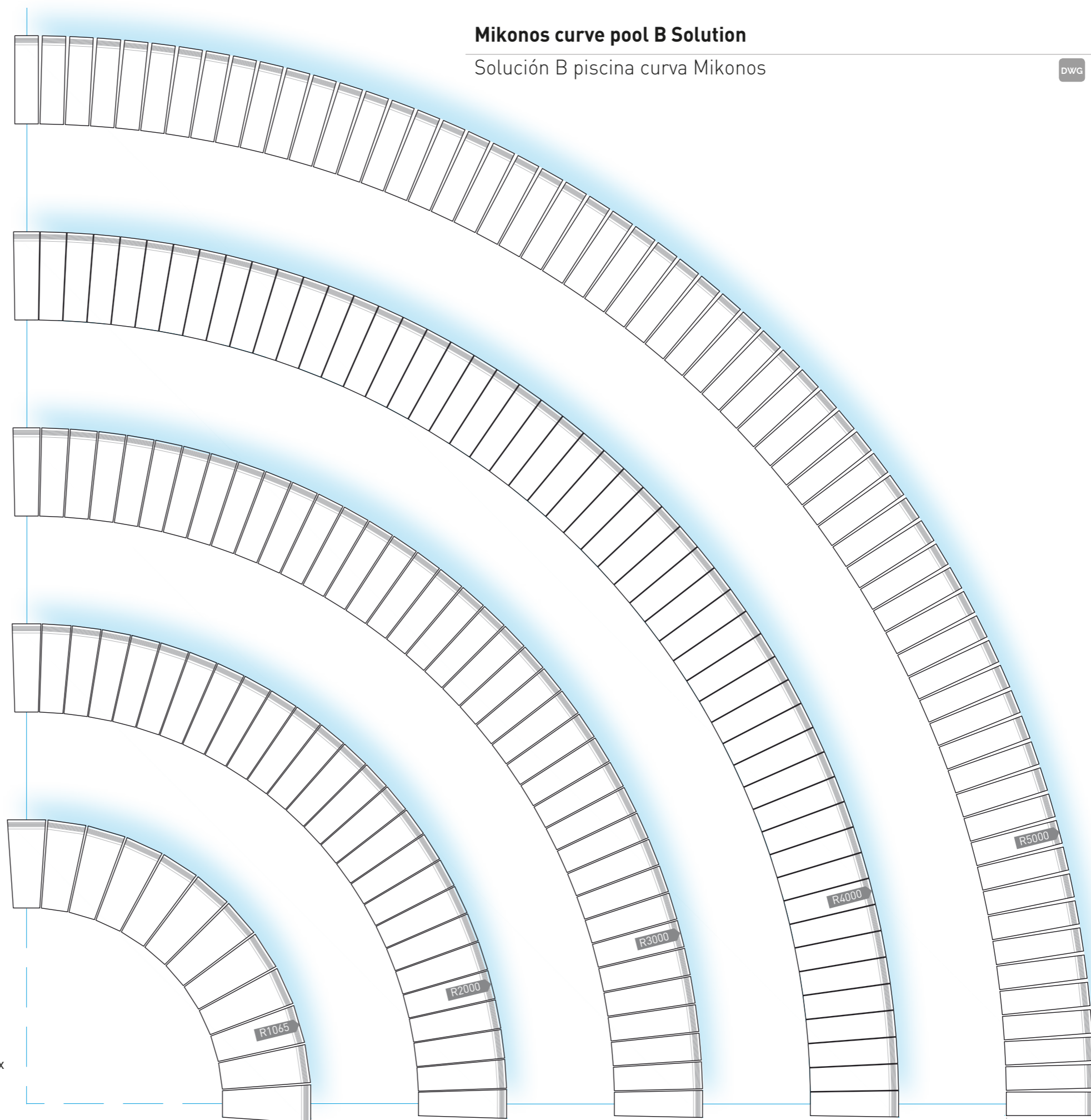





## CANARIAS



**OVERFLOWING SYSTEM**  
SISTEMA DESBORDANTE

Canarias System + RJ70 Grate System  
Color: Rainforest Blanco



**CANARIAS EDGE**  
BORDE CANARIAS  
Ref. BSCA 0000 18x50 **(M-729) pz**  
**MONOBLOCK**

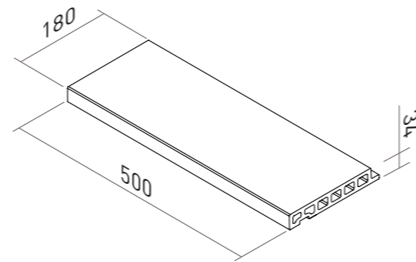

**CERAMIC DRAIN GRATE**  
REJILLA DE DRENAJE CERÁMICA  
Ref. RJ70 0000 20x50 **(M-731) pz**  
**MONOBLOCK**

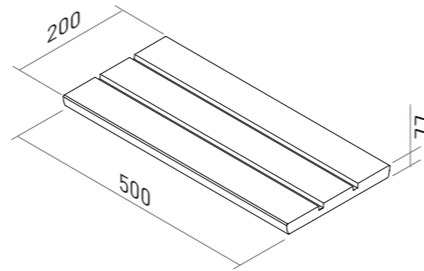

Component: Grate Rubber  
Componente: Goma p/Rejilla  
Art. 6491 **(M-250) ml**

Breaking Load  
Fuerza de rotura **>4000N**  
EN ISO 10545-4

Drain  
Desagüe **> 9.7 m³/hora**



**GRATE SUPPORT**  
SOPORTE P/REJILLA  
Ref. BSCA 0000 18x50 **(M-729) pz**  
**MONOBLOCK**

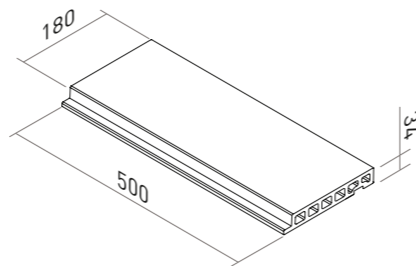

STROMBOLI\_silver



### OVERFLOWING SYSTEM DETAIL DETALLE SISTEMA DESBORDANTE

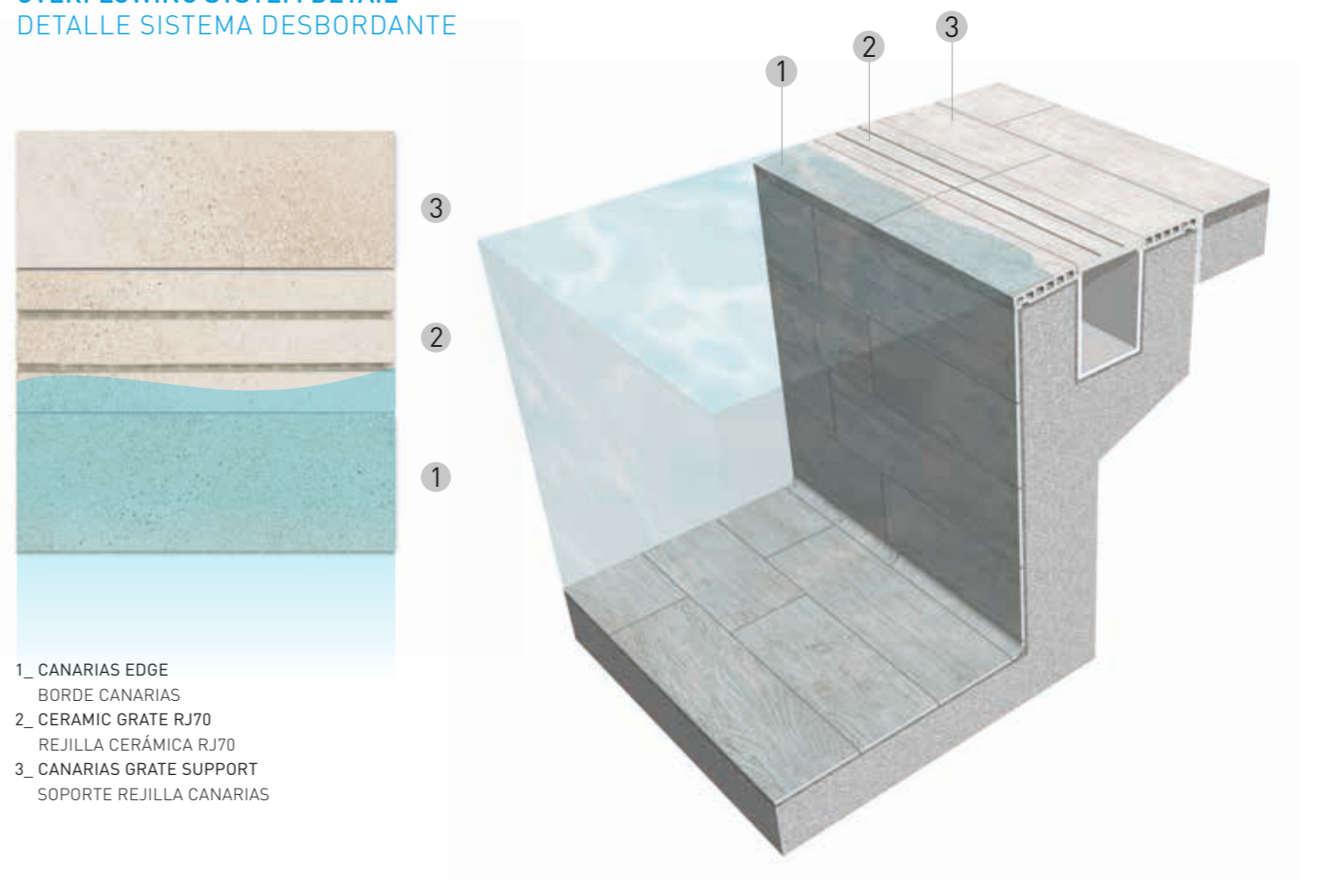

- 1\_ CANARIAS EDGE  
BORDE CANARIAS
- 2\_ CERAMIC GRATE RJ70  
REJILLA CERÁMICA RJ70
- 3\_ CANARIAS GRATE SUPPORT  
SOPORTE REJILLA CANARIAS

#### TECHNICAL INFORMATION INFORMACIÓN TÉCNICA

**MONOBLOCK** ONE PIECE WITHOUT GLUED  
UNA PIEZA, SIN PEGADO



Rainforest Blanco



Rainforest Musgo



Stromboli Light

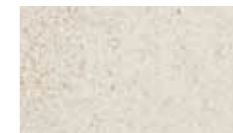

Stromboli Cream



Stromboli Silver

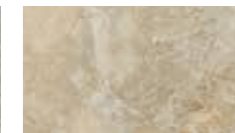

Sea Rock Caramel

## CORNER SOLUTION SOLUCIÓN ESQUINA



A

B

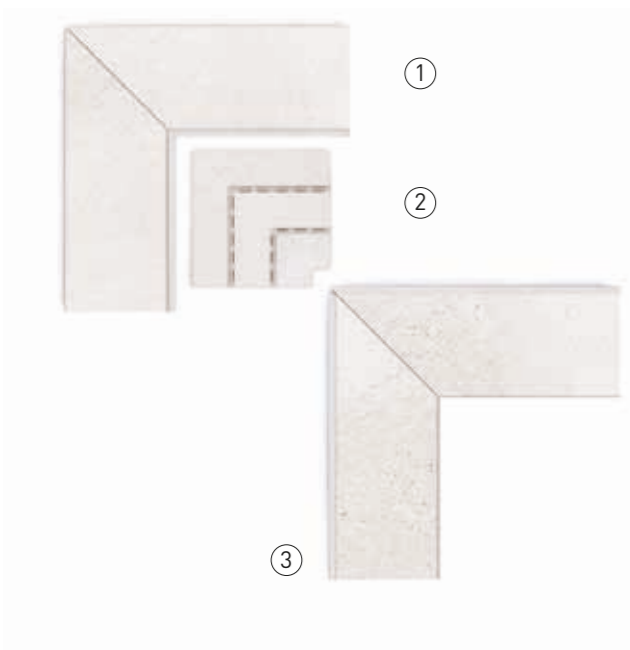

①

②

③



④

②

⑤

### CANARIAS CORNER GRATE SUPPORT SOPORTE ESQUINA CANARIAS P/REJILLA

- ① Ref. BSCA EE00 18x50 **(M-733) 2 pz**
- ④ Ref. BSCA EI00 18x50 **(M-733) 2 pz**

### CORNER CERAMIC GRATE ESQUINA REJILLA CERÁMICA

- ② Ref. RJ70 E000 20x20 **(M-732) 1pz**  
*Grates RJ55, RJ67 and RJ88 can also be used  
Compatible con las rejillas RJ55, RJ67 y RJ88*

### CANARIAS CORNER EDGE BORDE ESQUINA CANARIAS

- ③ Ref. BSCA EI00 18x50 **(M-733) 2 pz**
- ⑤ Ref. BSCA EE00 18x50 **(M-733) 2 pz**

## CURVED SOLUTION SOLUCIÓN CURVA



A

B



①

②

③



③

②

⑤

### CURVED GRATE SUPPORT SOPORTE P/REJILLA CURVA

- ① Ref. BSCA RE00 **(M-745) pz**
- ④ Ref. BSCA RI00 **(M-745) pz**

### CURVE GRATE **FLEXIBLE** REJILLA CURVA

- ② Ref. RJ88 RI01 25 **(M-583) 11 pz**
-  Grate bolts / included  
Pernos rejilla / incluidos  
Art. 6493 **(M-704) 25 pz**

### CANARIAS CURVED EDGE BORDE CANARIAS CURVO

- ③ Ref. BSCA RI00 **(M-745) pz**
- ⑤ Ref. BSCA RE00 **(M-745) pz**

## Straight system pieces with RJ70 Grate

Sistema de piezas en recto con Rejilla RJ70

DWG CA\_160517

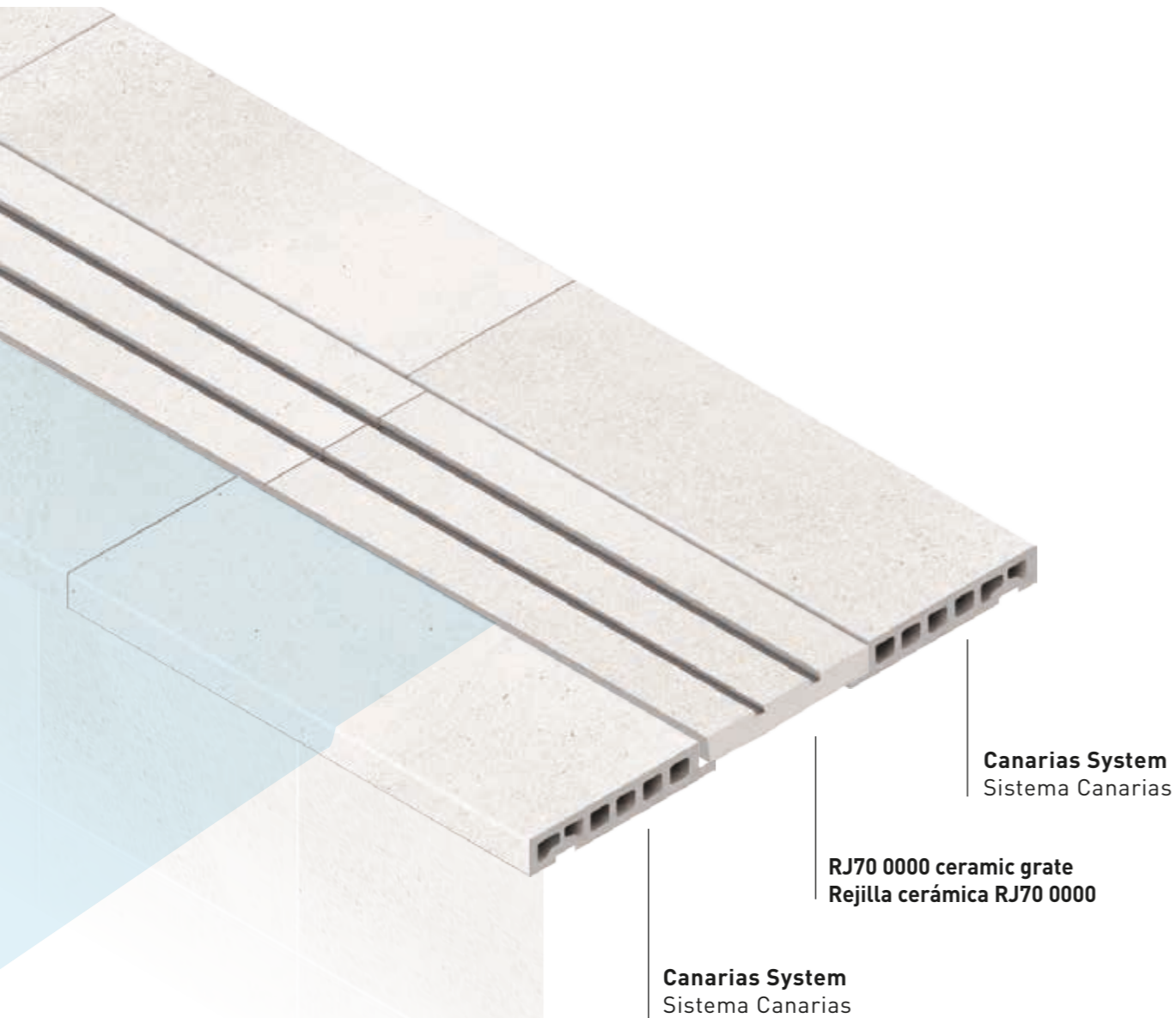

**Canarys grate support 18x50**  
Soporte rejilla Canarias 18x50  
Ref. BSCA 0000 18x50

**Ceramic grate 20x50**  
Rejilla cerámica 20x50  
Ref. RJ70 0000 20x50

**Canarys pool edge 18x50**  
Borde piscina Canarias 18x50  
Ref. BSCA 0000 18x50

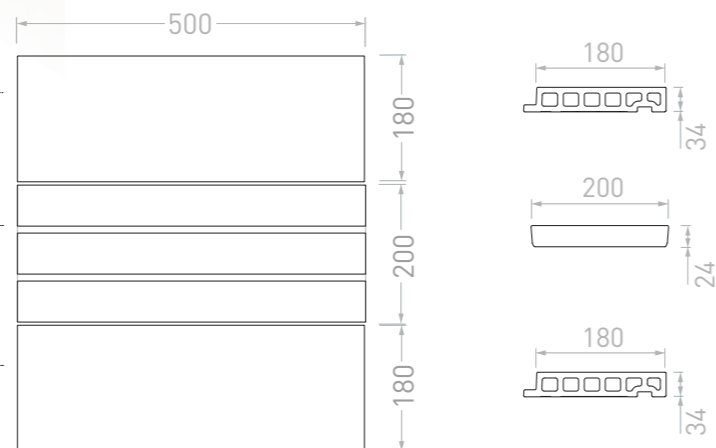

## Canarias detail system

Detalle del sistema Canarias

DWG CA\_160517

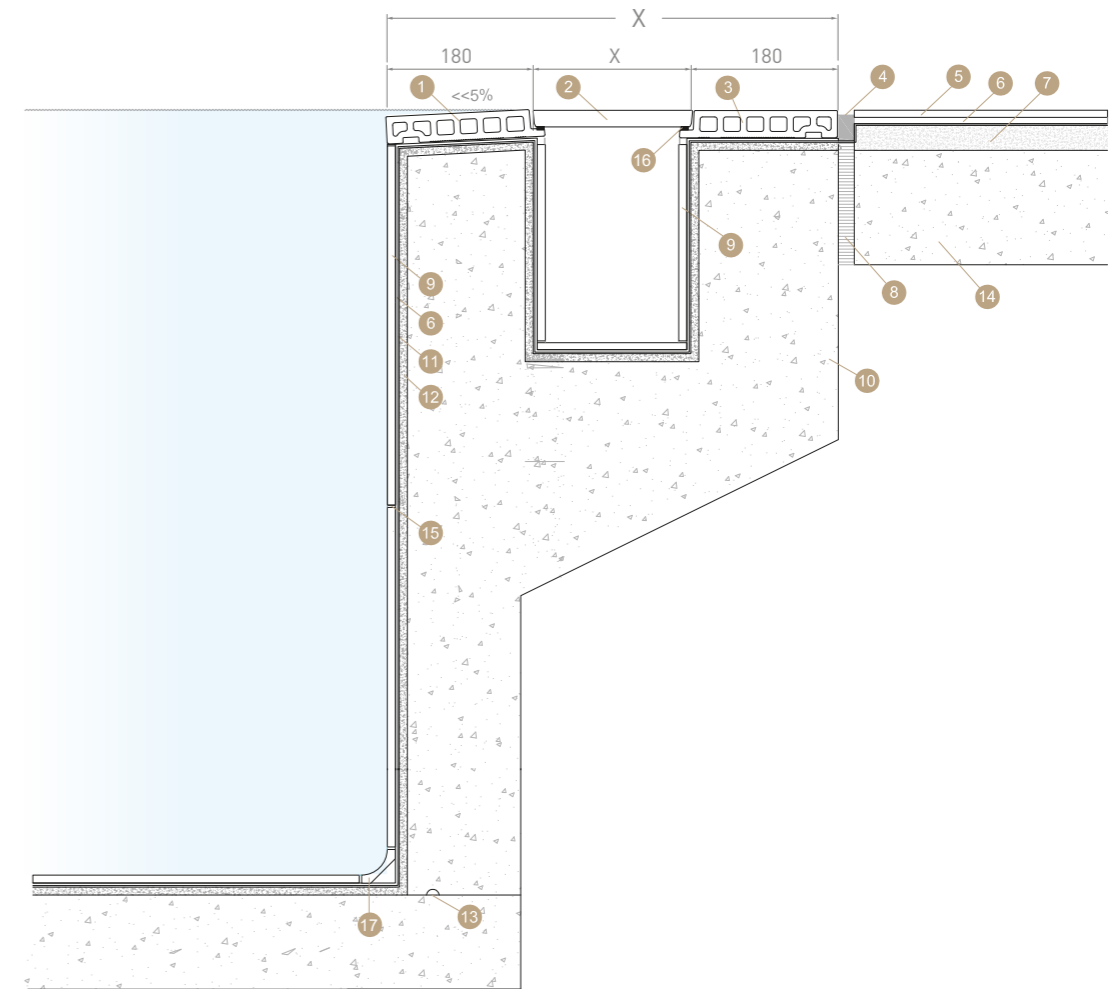

- |   |  |
|---|--|
| 1   Canarys Edge<br>Borde Canarias                              | 10   Concrete pool vessel<br>Hormigón vaso de piscina      |
| 2   Ceramic Grating RJ70 - RJ88<br>Rejilla Cerámica RJ70 - RJ88 | 11   Elastic waterproofing<br>Impermeabilización elástica  |
| 3   Canarys Support<br>Soporte Canarias                         | 12   Rendering regularisations<br>Revoco de regularización |
| 4   Expansion joint<br>Junta de dilatación                      | 13   Expansion joint<br>Junta de expansión                 |
| 5   Tiles<br>Base   | 14   Concrete deck<br>Solera de hormigón                   |
| 6   Cement glue<br>Mortero de agarre                            | 15   Grouted paste<br>Pasta de rejuntar                    |
| 7   Concrete in form of slopes<br>Hormigón formación pendientes | 16   Grate rubber<br>Goma rejilla                          |
| 8   Porexpan  | 17   Semi-circular piece<br>Media caña                     |
| 9   Interior Pool tile<br>Revestimiento interior de piscina     |  |

Corner Solutions with RJ70 Grate system

Soluciones de esquina con el sistema de Rejilla RJ70

DWG CA\_160517

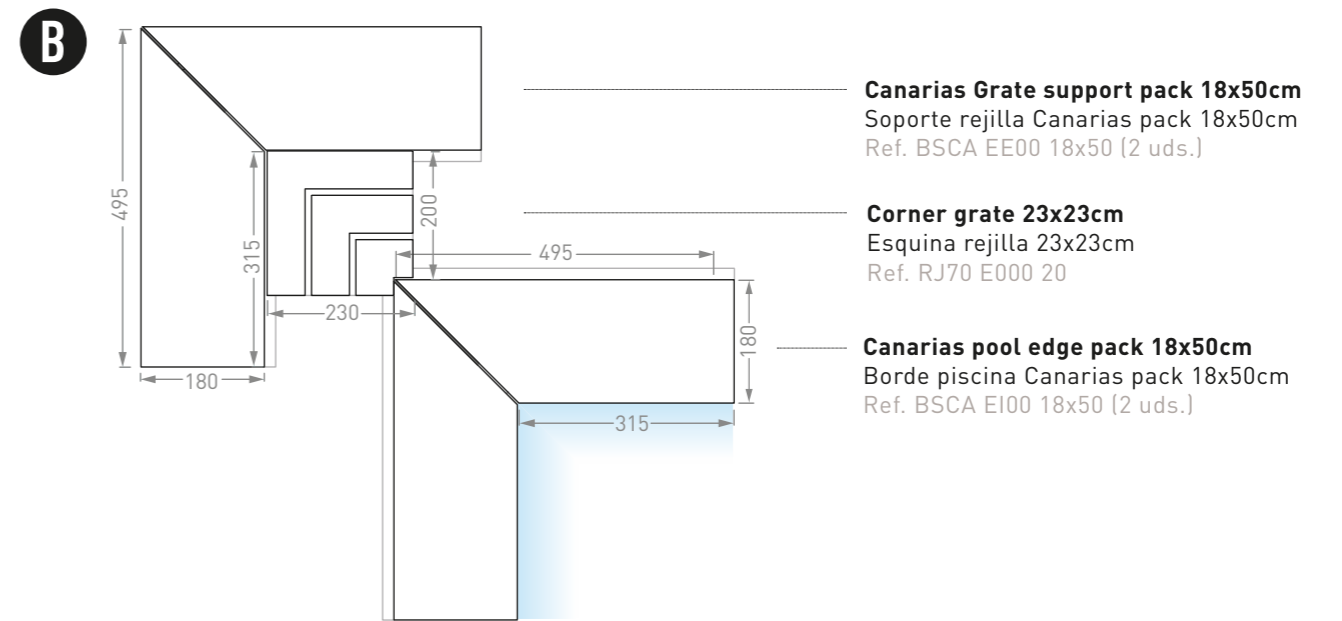
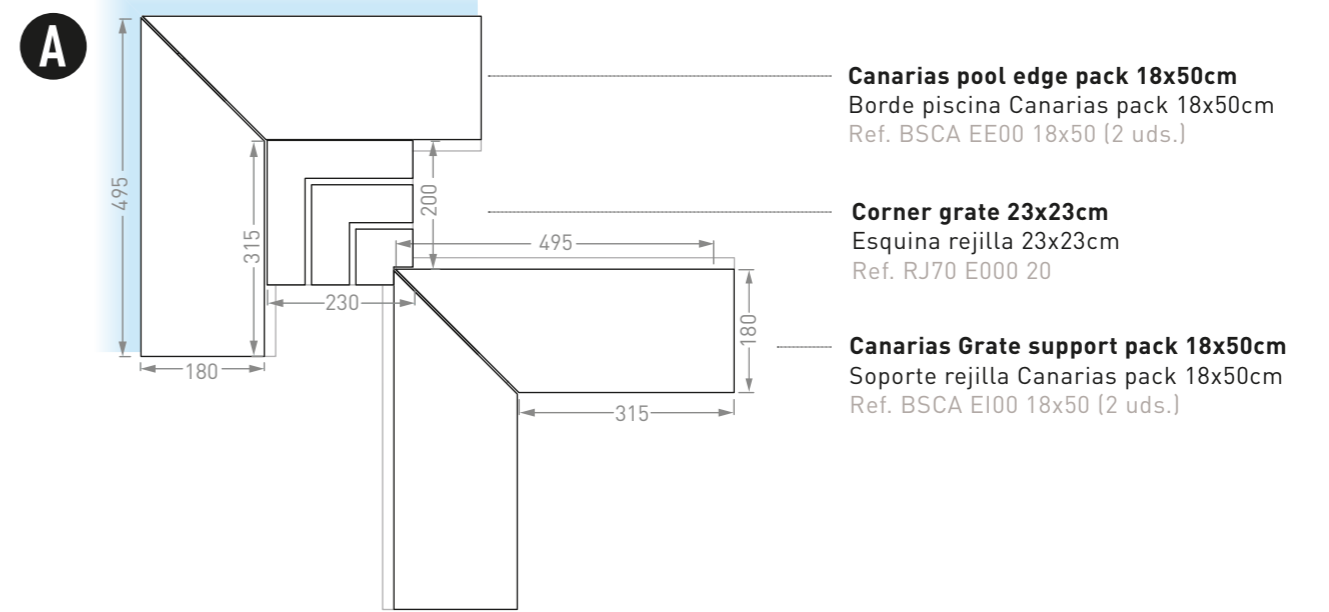
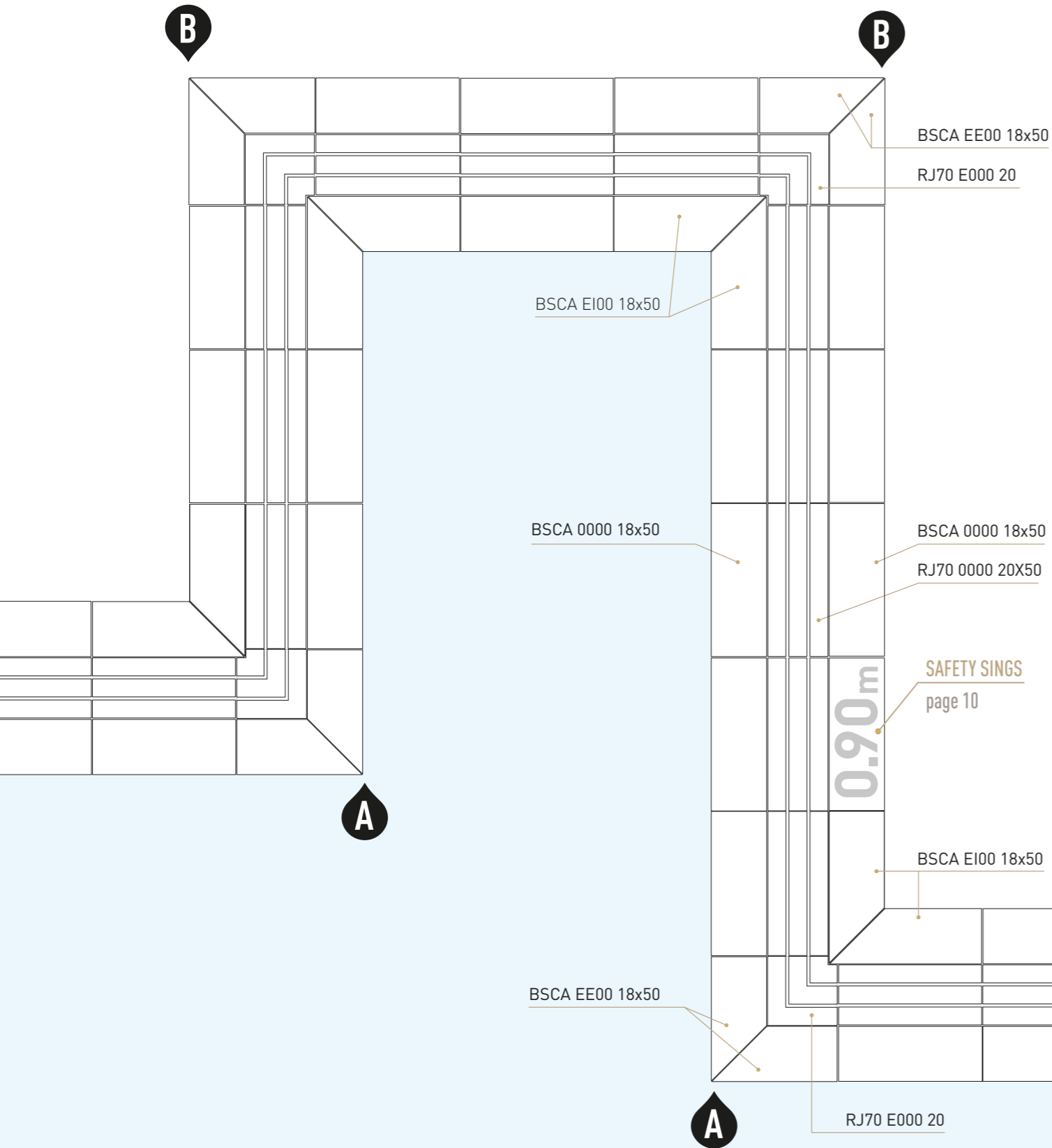

### Corner Solutions with RJ88 Grate system

Soluciones de esquina con el sistema de Rejilla RJ88

DWG CA\_160517

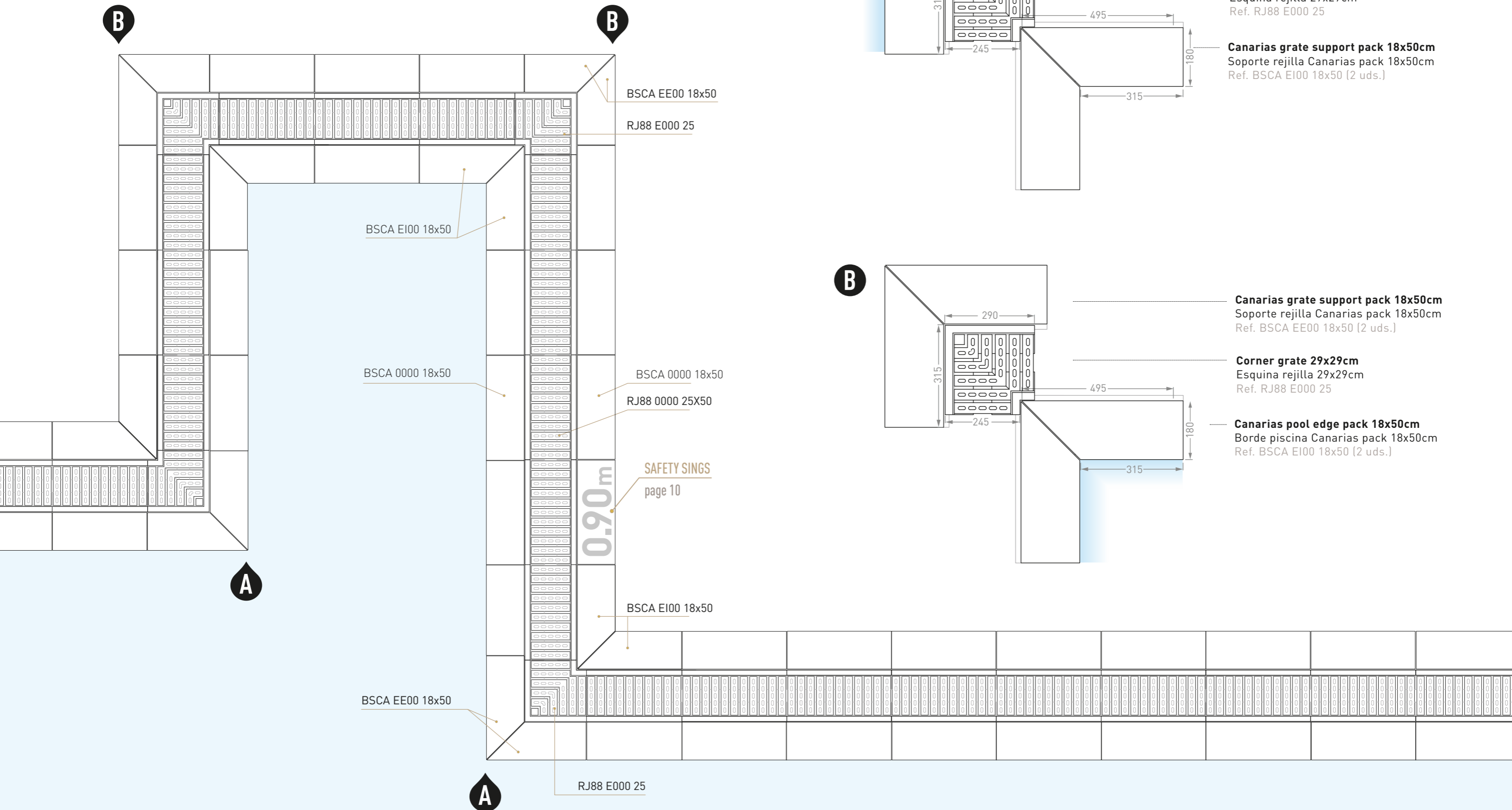

**Canarias pool edge pack 18x50cm**  
Borde piscina Canarias pack 18x50cm  
Ref. BSCA EE00 18x50 (2 uds.)

**Corner grate 29x29cm**  
Esquina rejilla 29x29cm  
Ref. RJ88 E000 25

**Canarias grate support pack 18x50cm**  
Soporte rejilla Canarias pack 18x50cm  
Ref. BSCA EI00 18x50 (2 uds.)

**Canarias grate support pack 18x50cm**  
Soporte rejilla Canarias pack 18x50cm  
Ref. BSCA EE00 18x50 (2 uds.)

**Corner grate 29x29cm**  
Esquina rejilla 29x29cm  
Ref. RJ88 E000 25

**Canarias pool edge pack 18x50cm**  
Borde piscina Canarias pack 18x50cm  
Ref. BSCA EI00 18x50 (2 uds.)

**Curve corners samples with RJ88 Grate**

Ejemplos esquina curva con Rejilla RJ88

DWG CA\_160517

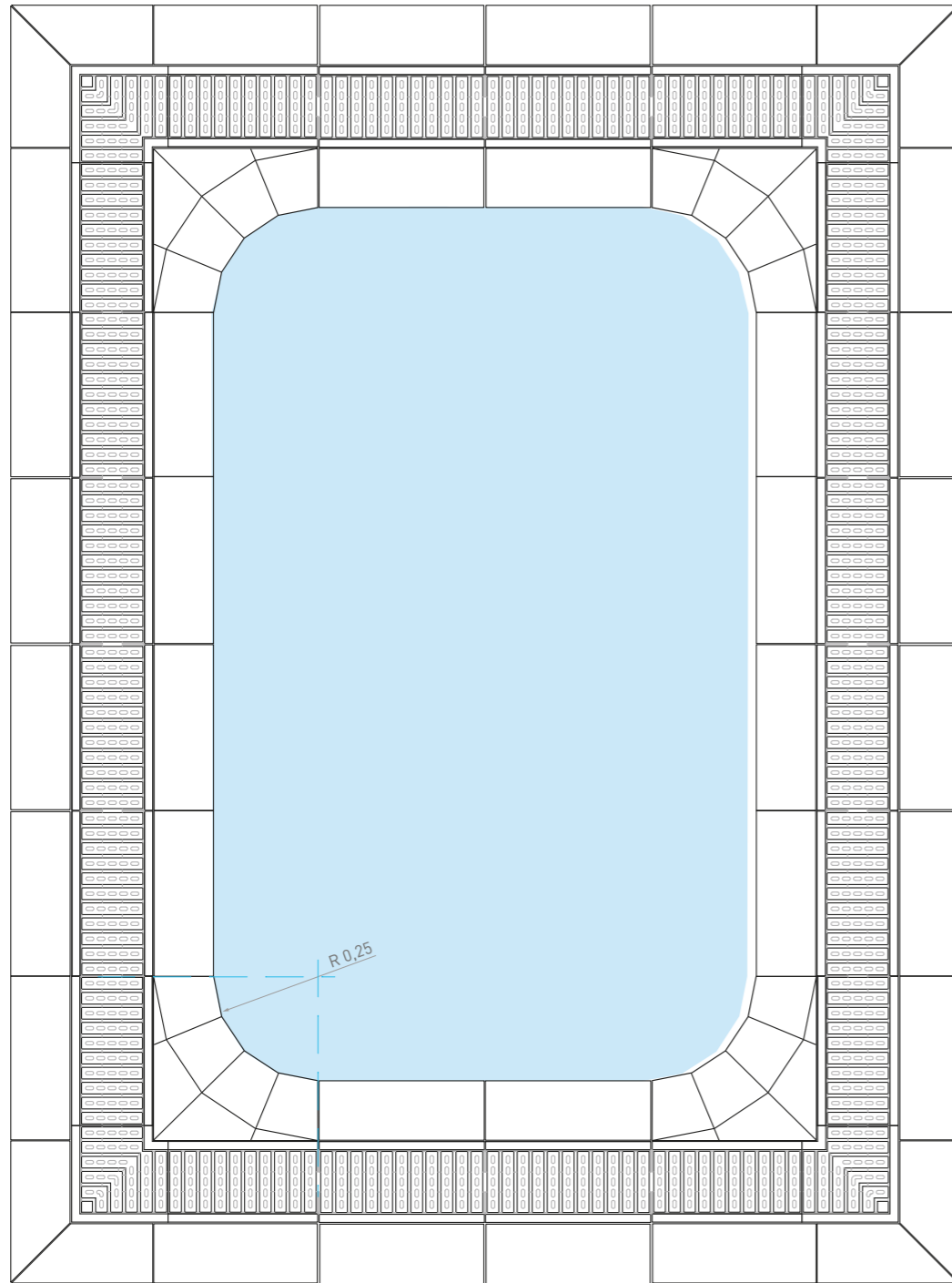

**Curve corner samples with RJ70 Grate**

Ejemplos esquina curva con Rejilla RJ70

DWG CA\_160517

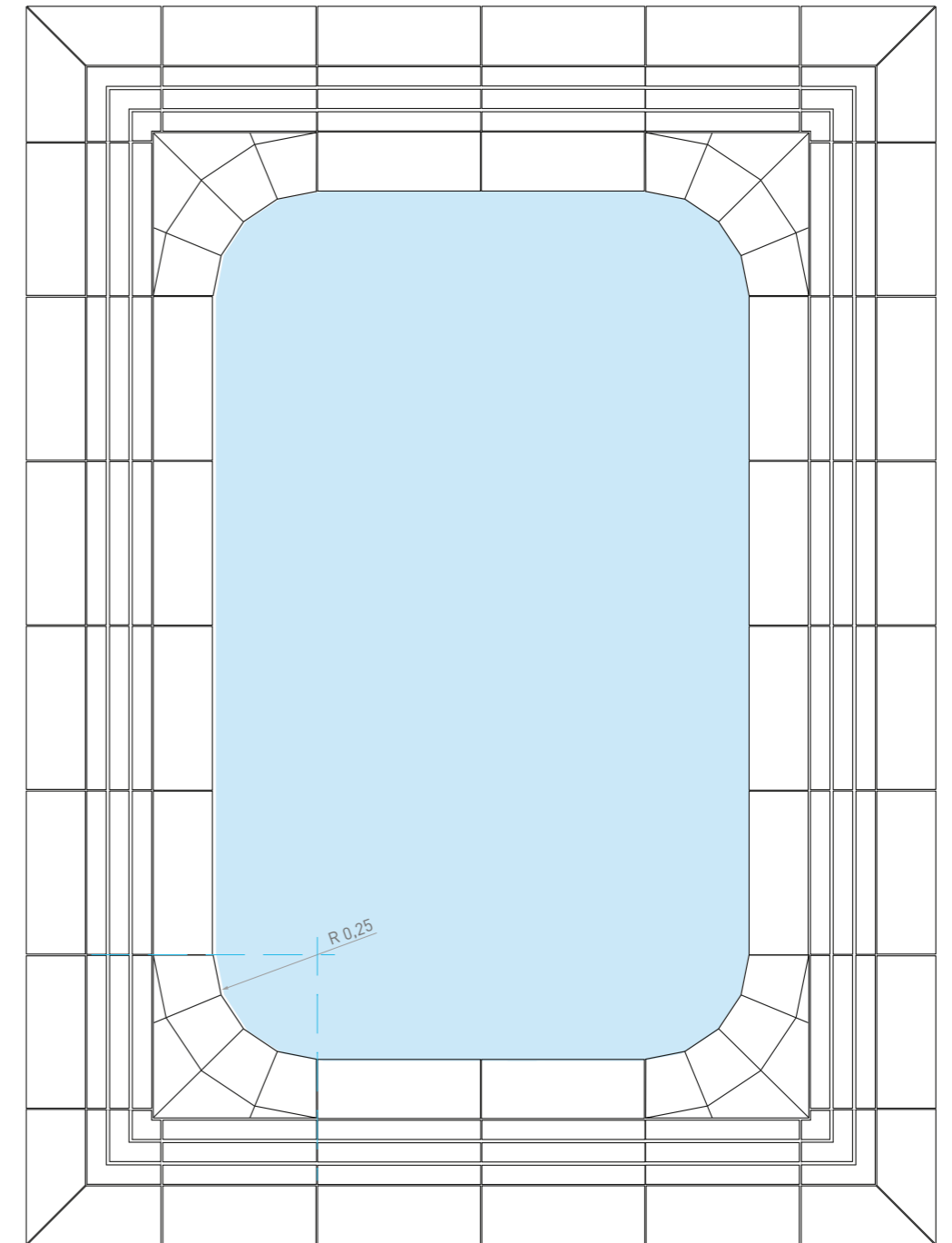

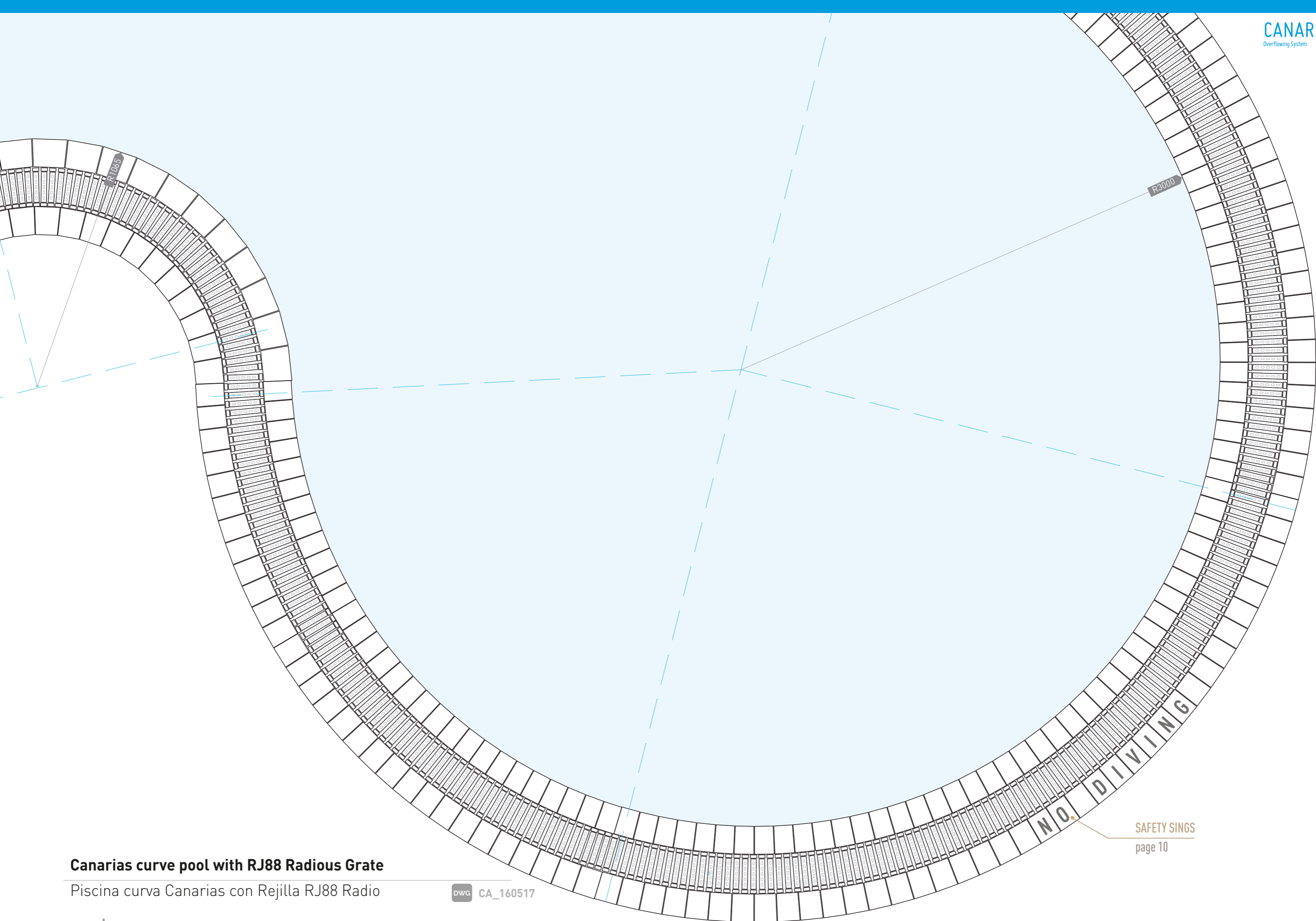

**Canarias curve pool with RJ88 Radius Grate**

Piscina curva Canarias con Rejilla RJ88 Radio

DWG CA\_160517

NO DIVING  
SAFETY SINGS  
page 10



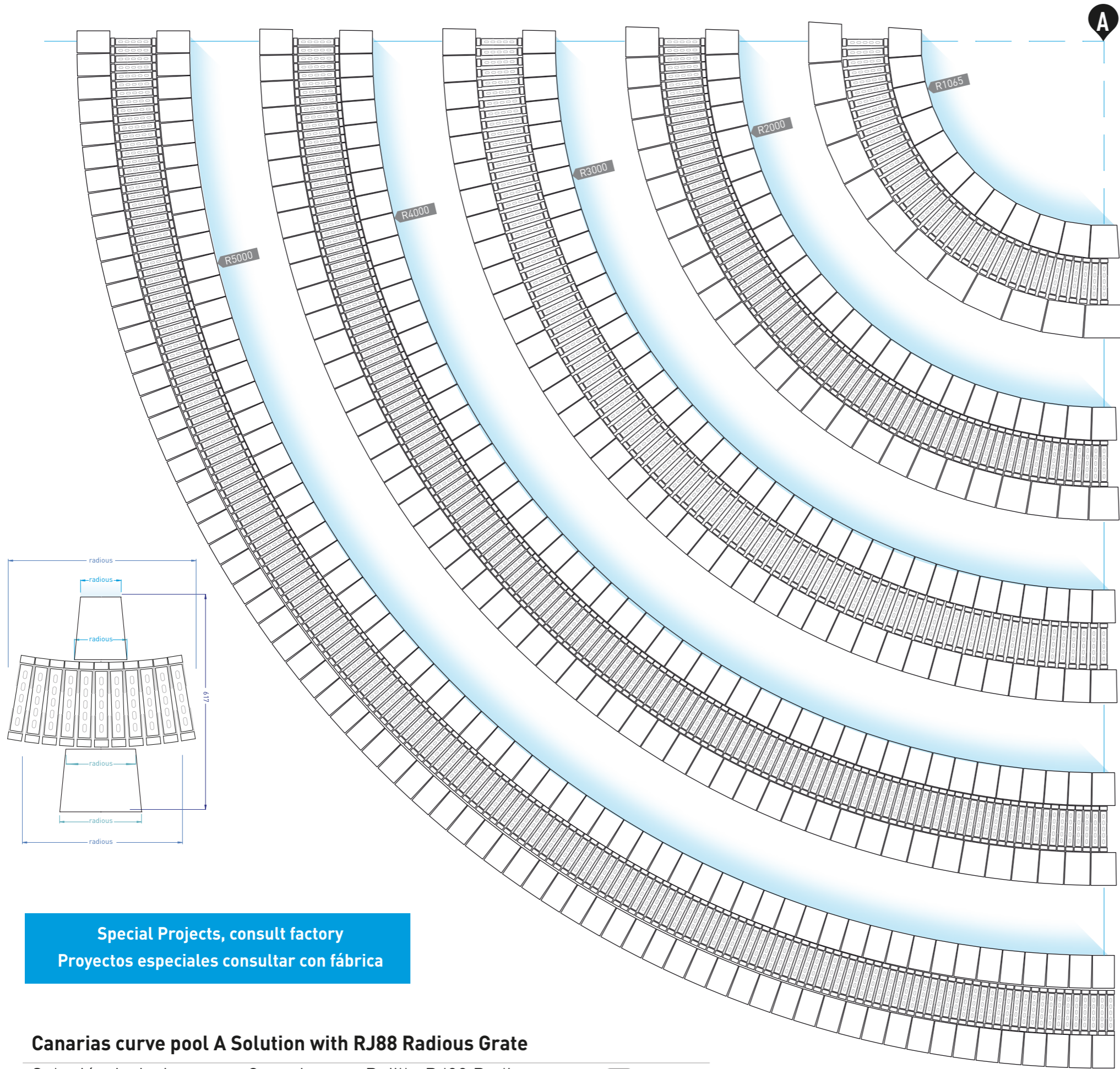

Special Projects, consult factory  
Proyectos especiales consultar con fábrica

**Canarias curve pool A Solution with RJ88 Radius Grate**

Solución A piscina curva Canarias con Rejilla RJ88 Radio

DWG CA\_160517

**CANARIAS SYSTEM**  
**Grate support**  
SISTEMA CANARIAS  
Soporte rejilla

**HAWAII CURVE GRATE**  
REJILLA CURVA HAWAII

**CANARIAS SYSTEM**  
**Pool edge**  
SISTEMA CANARIAS  
Borde piscina

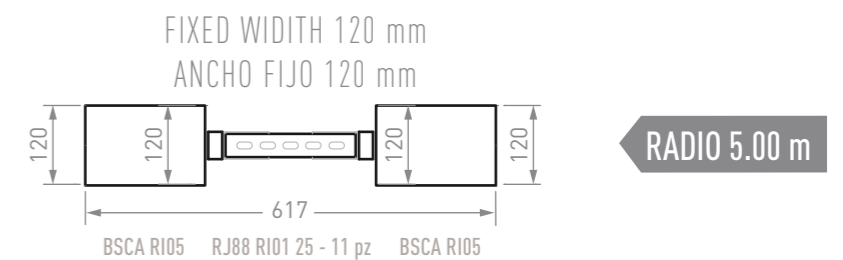
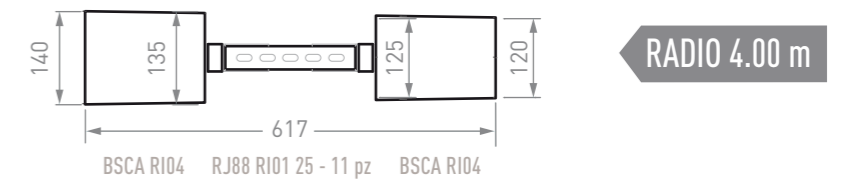
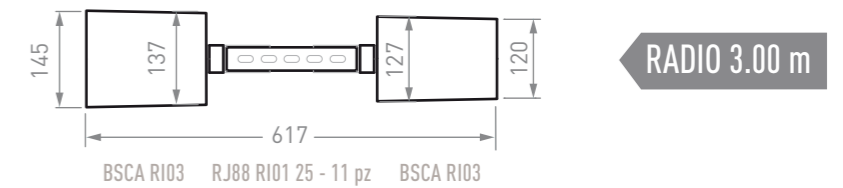
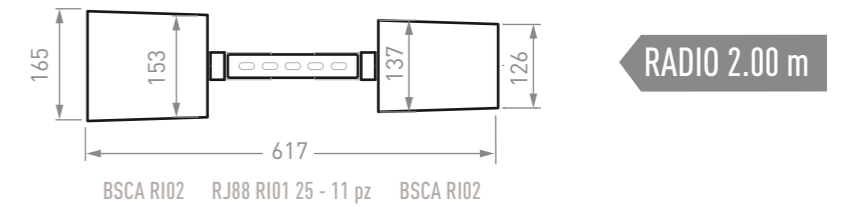
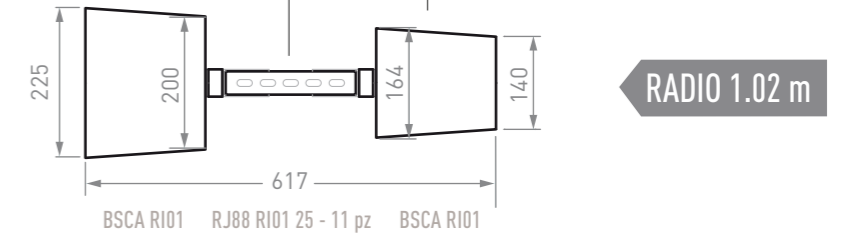

Canarias curve pool B Solution with RJ88 Radius Grate

Solución B piscina curva Canarias con Rejilla RJ88 Radio

DWG CA\_160517

Special projects, consult factory  
Proyectos especiales consultar con fábrica

RADIO 5.00 m

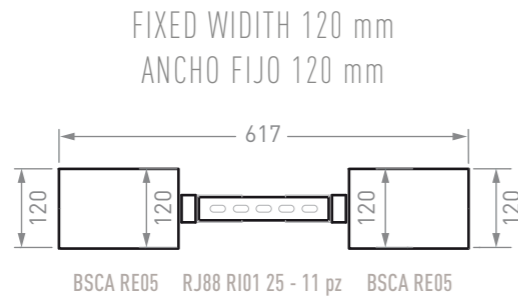

RADIO 4.00 m

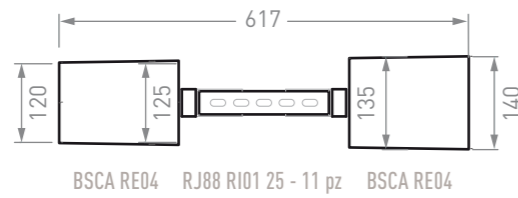

RADIO 3.00 m

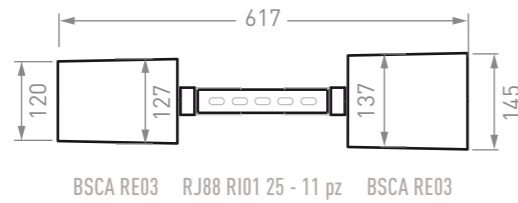

RADIO 2.00 m

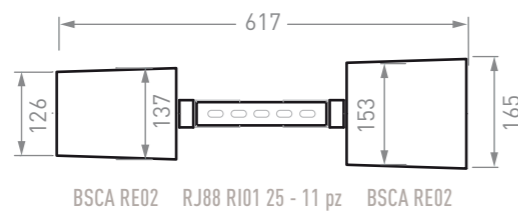

RADIO 1.06 m

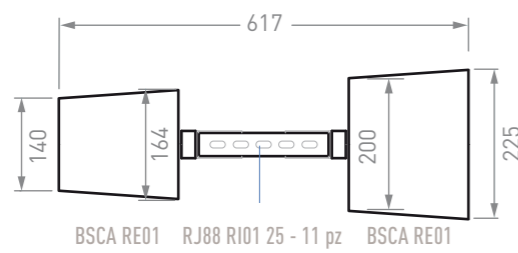

CANARIAS SYSTEM  
Grate support  
SISTEMA CANARIAS  
Soporte rejilla

HAWAII CURVE GRATE  
REJILLA CURVA HAWAII

CANARIAS SYSTEM  
Pool edge  
SISTEMA CANARIAS  
Borde piscina

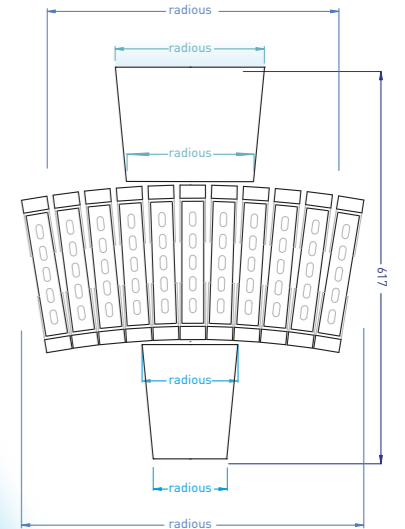
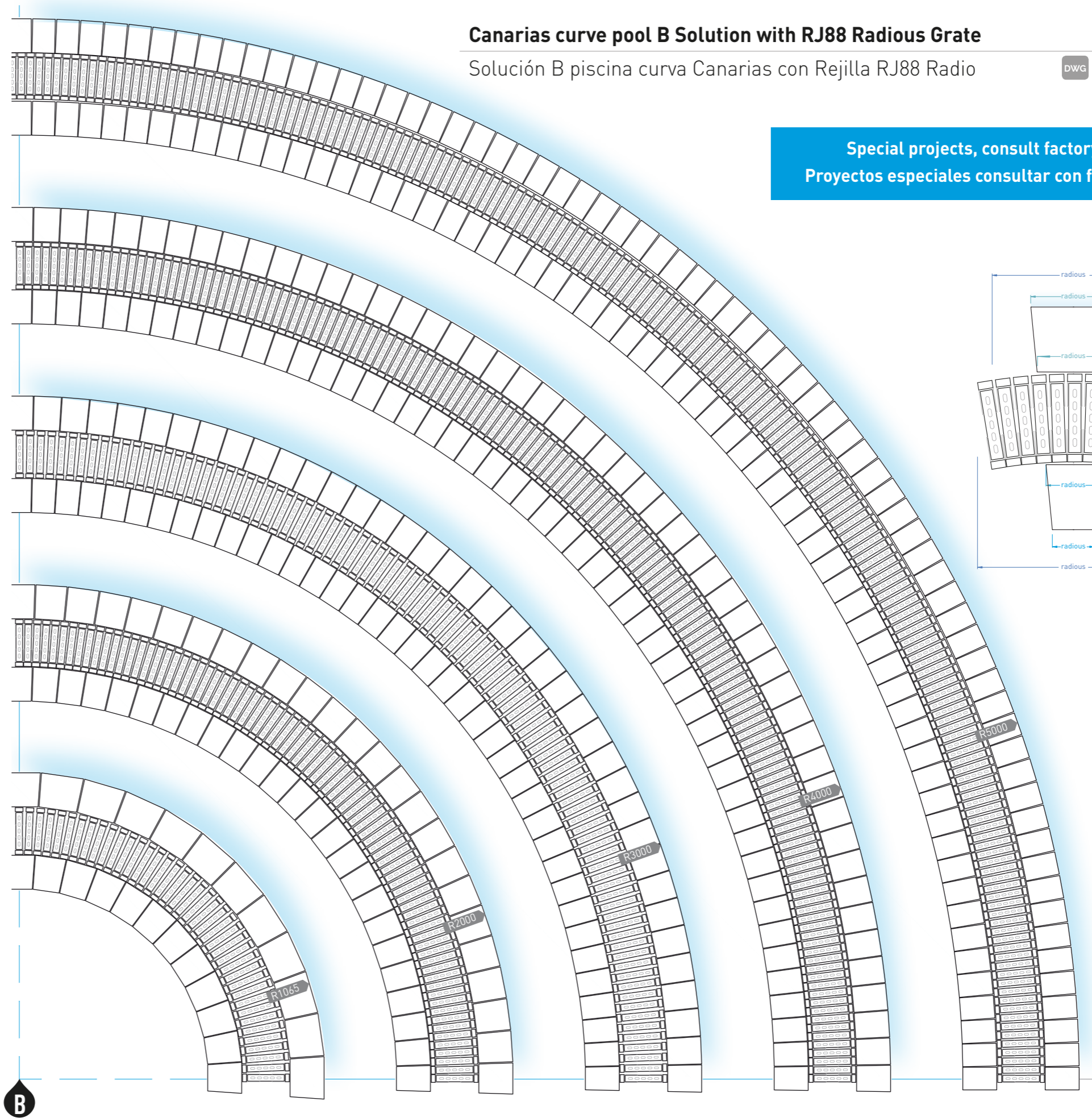

B



## BORA



**OVERFLOWING SYSTEM**  
SISTEMA DESBORDANTE

Bora System + RJ55 Grate System  
Color: Stromboli Light



**BORA EDGE**  
BORDE BORA  
Ref. BPBO 0000 20x50 (M-758) pz  
MONOBLOCK

OVERFLOWING >>3,2%

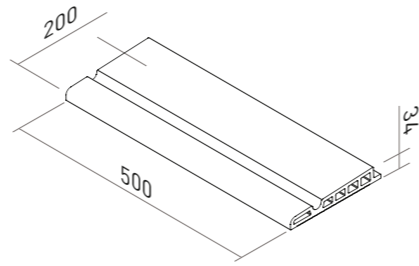

**CERAMIC DRAIN GRATE**  
REJILLA DE DRENAJE CERÁMICA  
Ref. RJ55 0000 20x50 (M-759) pz  
MONOBLOCK

ANTISHOCK



Component: Grate Rubber included  
Componente: Goma p/Rejilla incluida  
Art. 7966 (M-771) ml

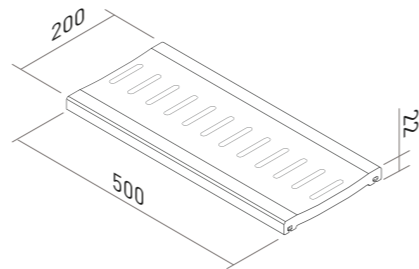

Worldwide Patent  
Patente Mundial

Breaking Load  
Fuerza de rotura >4000N

EN ISO 10545-4

Drain  
Desagüe

> 19.4 m<sup>3</sup>/hora



**GRATE SUPPORT**  
SOPORTE P/REJILLA  
Ref. BSCA 0000 18x50 (M-729) pz  
MONOBLOCK

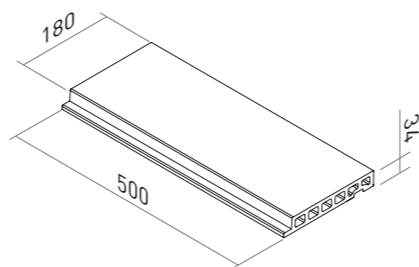

## OVERFLOWING SYSTEM DETAIL DETALLE SISTEMA DESBORDANTE

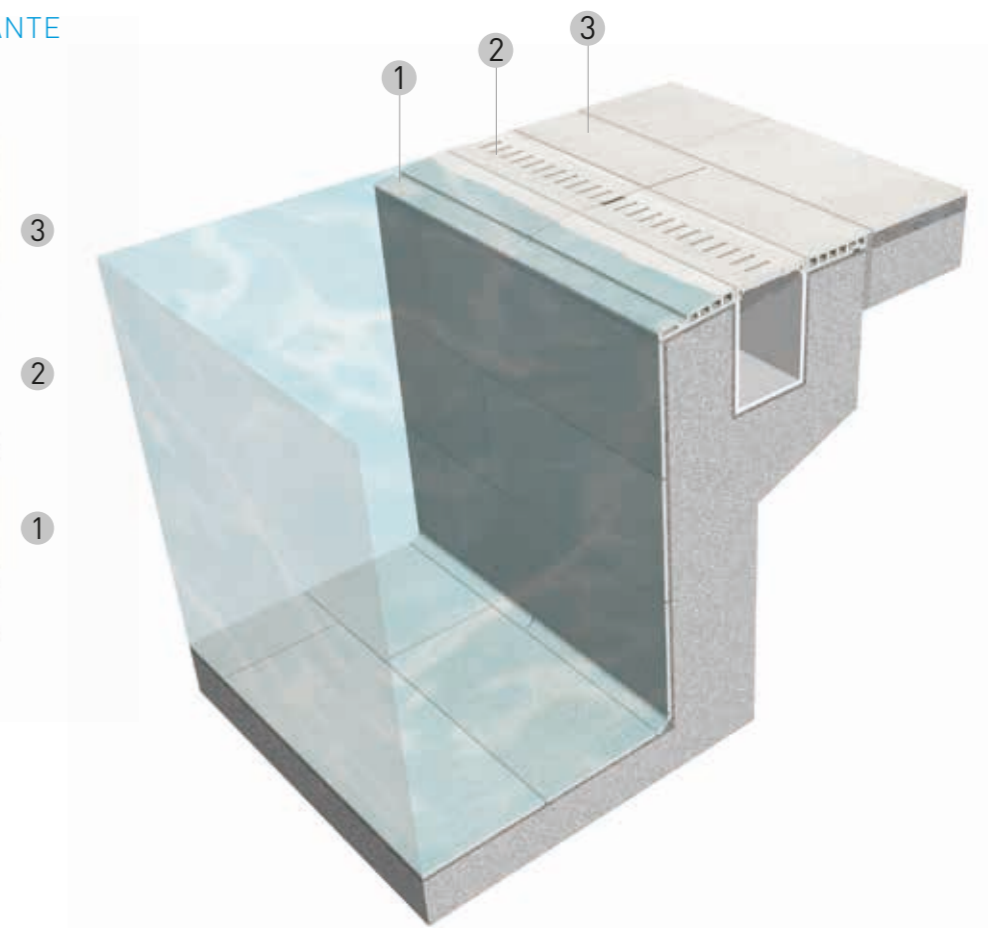

- 1\_ BORA EDGE  
BORDE BORA
- 2\_ CERAMIC GRATE RJ55  
REJILLA CERÁMICA RJ55
- 3\_ BORA GRATE SUPPORT  
SOPORTE REJILLA BORA

### TECHNICAL INFORMATION INFORMACIÓN TÉCNICA

**MONOBLOCK** ONE PIECE WITHOUT GLUED  
UNA PIEZA, SIN PEGADO

UNE ENV 12633  
Clase 3

DIN 51130  
R11

DIN 51097  
Clase C

EN ISO 10545-12

EN ISO 10545-13  
GA / GLA / GHA

NOISELESS  
SILENCIOSO

LONG LIFE  
LARGA VIDA

EASY  
FÁCIL



Stromboli Light



Stromboli Cream



Stromboli Silver

## CORNER SOLUTION SOLUCIÓN ESQUINA

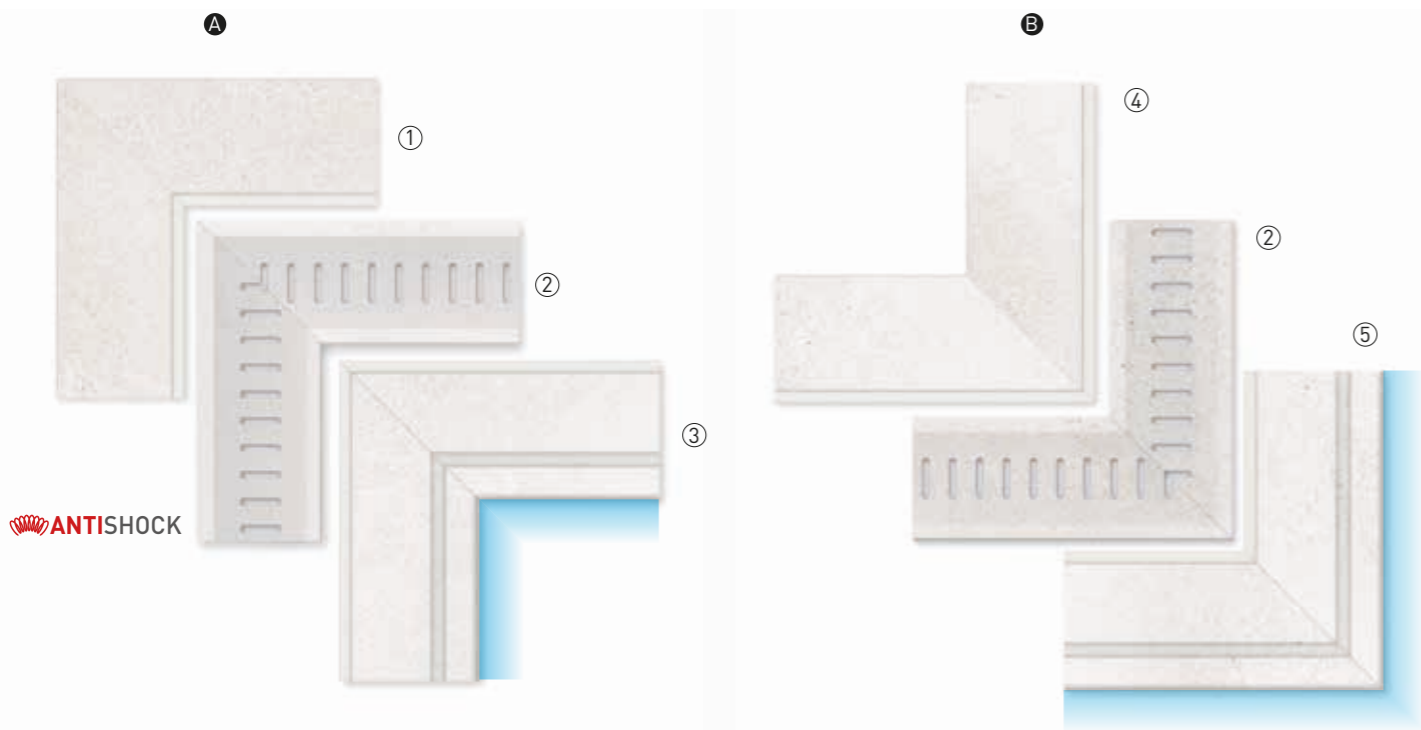

### CORNER GRATE SUPPORT SOPORTE ESQUINA P/REJILLA

- ① Ref. BSCA EE00 18x50 **(M-733)** 2 pz
- ④ Ref. BSCA EI00 18x50 **(M-733)** 2 pz

### CORNER CERAMIC GRATE ESQUINA REJILLA CERÁMICA

- ② Ref. RJ55 E000 20x\_ **(M-766)** pz

**ANTISHOCK**

Grates RJ66, RJ70 and RJ88 can also be used  
Compatible con las rejillas RJ66, RJ70 y RJ88

### BORA CORNER EDGE BORDE ESQUINA BORA

- ③ BPBO EI00 20x\_ **(M-765)** 2 pzs
- ⑤ BPBO EE00 20x\_ **(M-765)** 2 pzs

## CURVE SOLUTION SOLUCIÓN CURVA



Special Projects, consult factory. Extra cost Ref. 6624 **(M-600)** pz  
Proyectos especiales consultar con fábrica. Coste extra Ref. 6624 **(M-600)** pz



### CURVED GRATE SUPPORT SOPORTE P/REJILLA CURVA

- ① Ref. BSCA RE00 **(M-745)** pz
- ④ Ref. BSCA RI00 **(M-745)** pz

### CURVE GRATE REJILLA CURVA

- ② Ref. RJ55 R000 20x\_ **(M-778)** pz

**ANTISHOCK**

Curved grate RJ88 RI01 can also be used  
Compatible con las rejilla curva RJ88 RI01

### BORA CURVED EDGE BORDE CURVO BORA

- ③ Ref. BPBO RI00 20x\_ **(M-767)** 2 pzs
- ⑤ Ref. BPBO RE00 20x\_ **(M-767)** 2 pzs

# Straight system pieces with RJ55 Grate

Sistema de piezas en recto con Rejilla RJ55

DWG BO\_271117

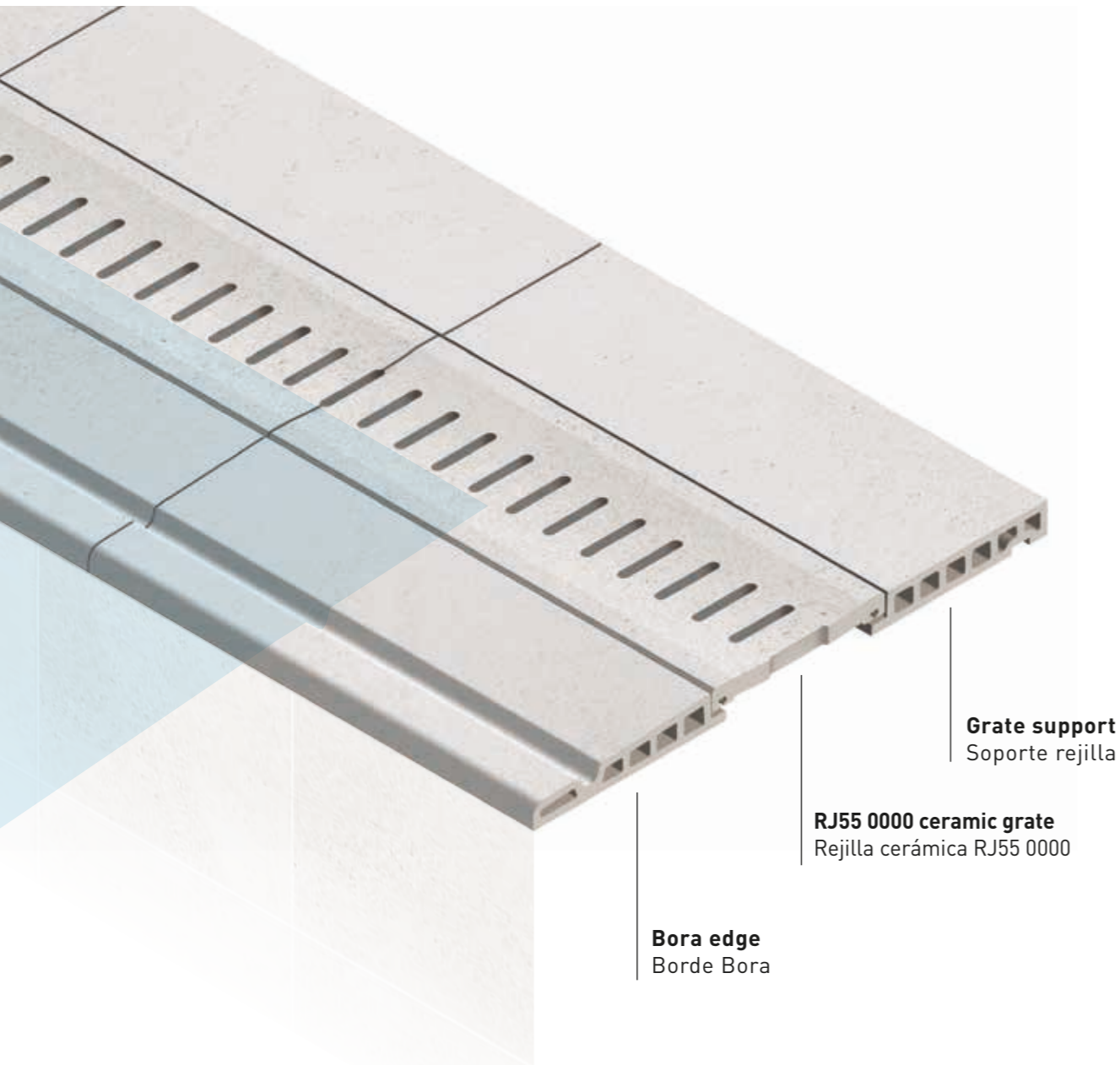

Grate support  
Soporte rejilla

RJ55 0000 ceramic grate  
Rejilla cerámica RJ55 0000

Bora edge  
Borde Bora

Grate support 18x50  
Soporte rejilla 18x50  
Ref. BSCA 0000 18x50

Ceramic grate 20x50  
Rejilla cerámica 20x50  
Ref. RJ55 0000 20x50

Bora pool edge 20x50  
Borde piscina Bora 20x50  
Ref. BSBO 0000 20x50

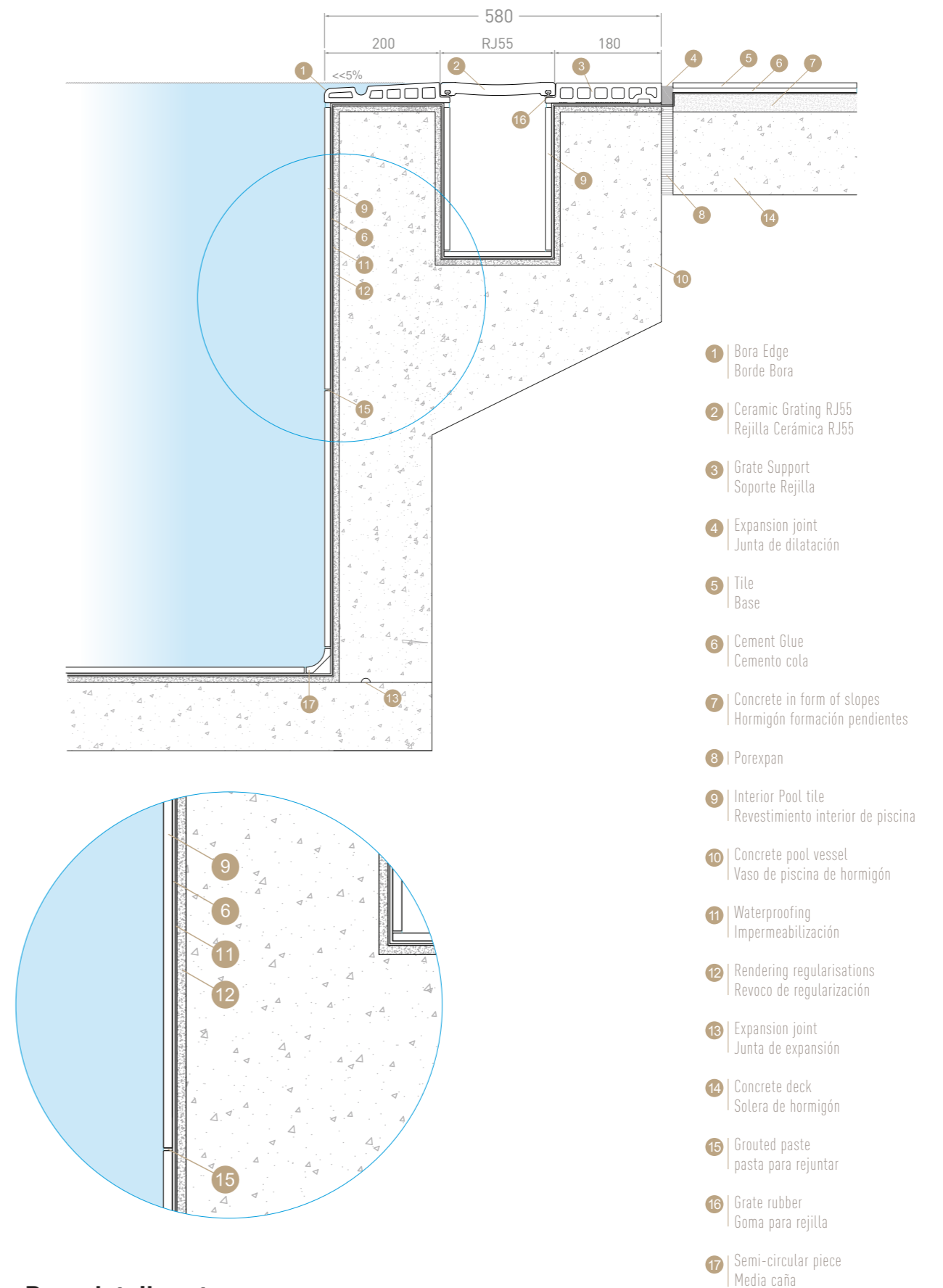
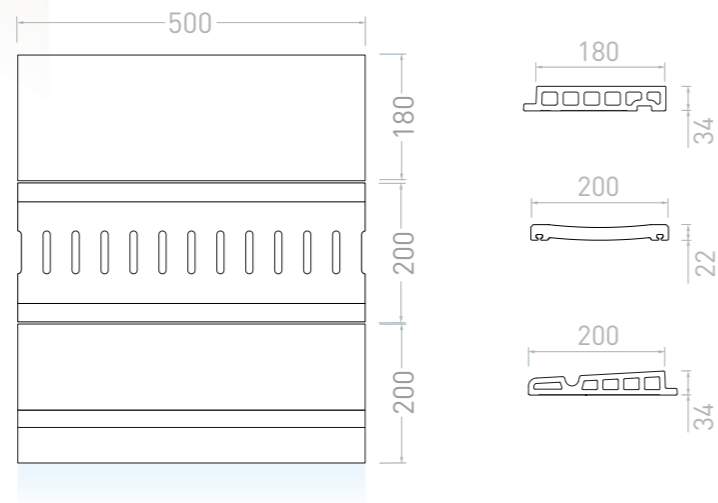

## Bora detail system

Detalle del sistema Bora

DWG BO\_271117

## Corner Solutions with RJ55 Grate system

Soluciones de esquina con el sistema de Rejilla RJ55

DWG BO\_120218

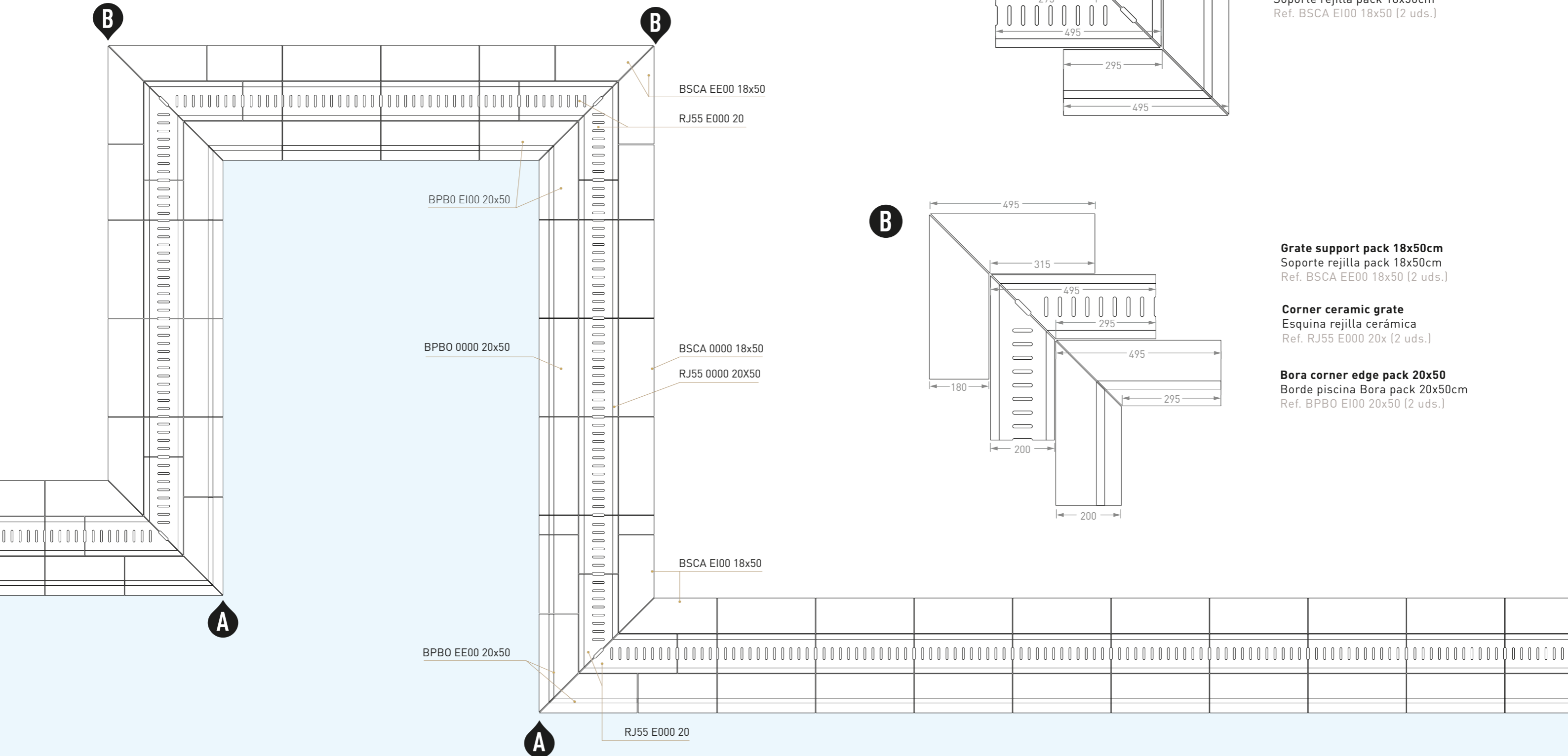

A

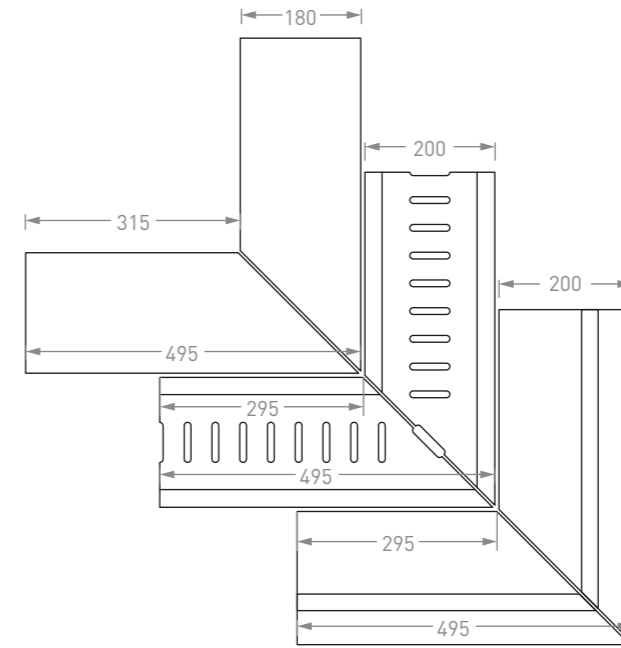

**Bora corner edge pack 20x50**  
 Borde piscina Bora pack 20x50cm  
 Ref. BPBO EE00 20x50 (2 uds.)

**Corner ceramic grate**  
 Esquina rejilla cerámica  
 Ref. RJ55 E000 20x (2 uds.)

**Grate support pack 18x50cm**  
 Soporte rejilla pack 18x50cm  
 Ref. BSCA EI00 18x50 (2 uds.)

B

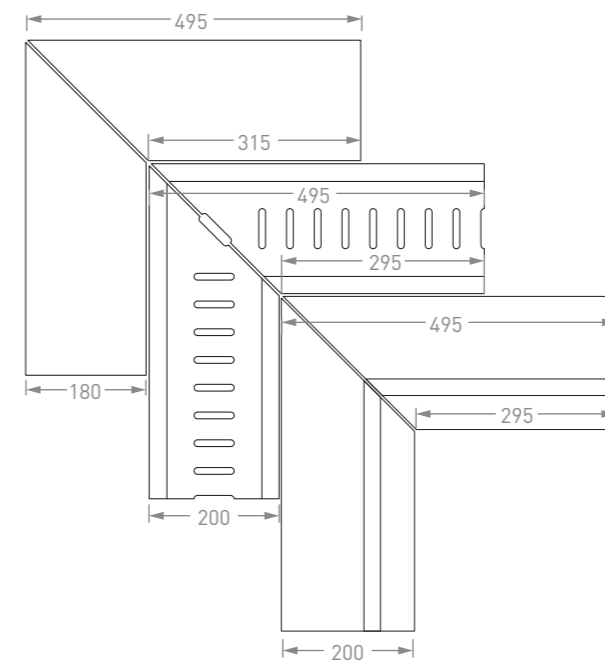

**Grate support pack 18x50cm**  
 Soporte rejilla pack 18x50cm  
 Ref. BSCA EE00 18x50 (2 uds.)

**Corner ceramic grate**  
 Esquina rejilla cerámica  
 Ref. RJ55 E000 20x (2 uds.)

**Bora corner edge pack 20x50**  
 Borde piscina Bora pack 20x50cm  
 Ref. BPBO EI00 20x50 (2 uds.)

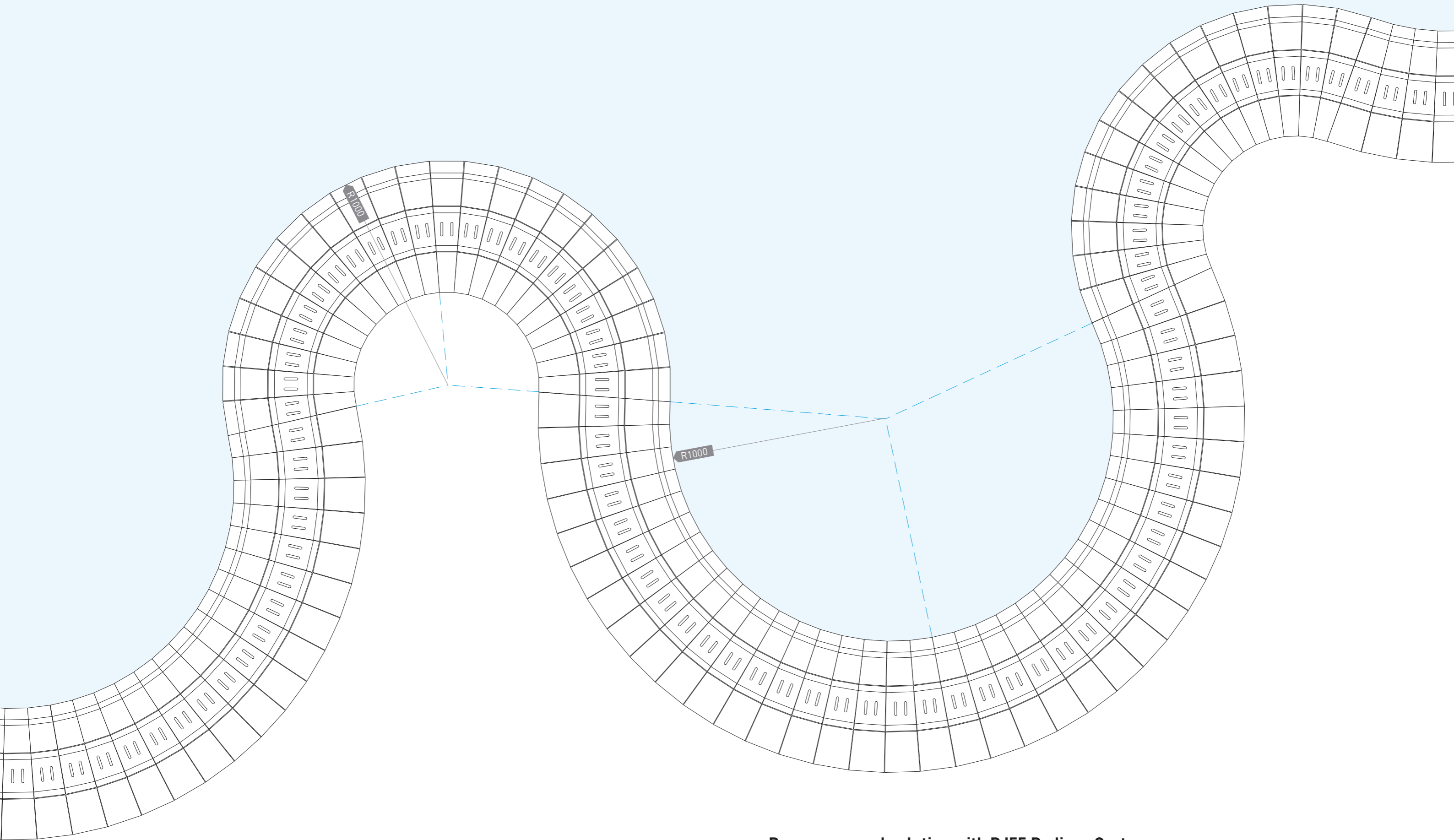

**Bora curve pool solution with RJ55 Radius Grate**

Solución piscina curva Bora con Rejilla RJ55 Radio

DWG BO\_120218



# Bora curve pool solution with RJ55 Radius Grate

Solución piscina curva Bora con Rejilla RJ55 Radio

DWG BO\_120218

- CURVE GRATE**  
REJILLA CURVA  
REF. RJ55 R000 20X\_ (M-778) PZ  

- CORNER GRATE SUPPORT**  
SOPORTE ESQUINA P/REJILLA  
REF. BSCA RI00 (M-745) PZ
- BORA CURVED EDGE**  
BORDE CURVO BORA  
REF. BPBO RE00 20X\_ (M-767) 2 PZS

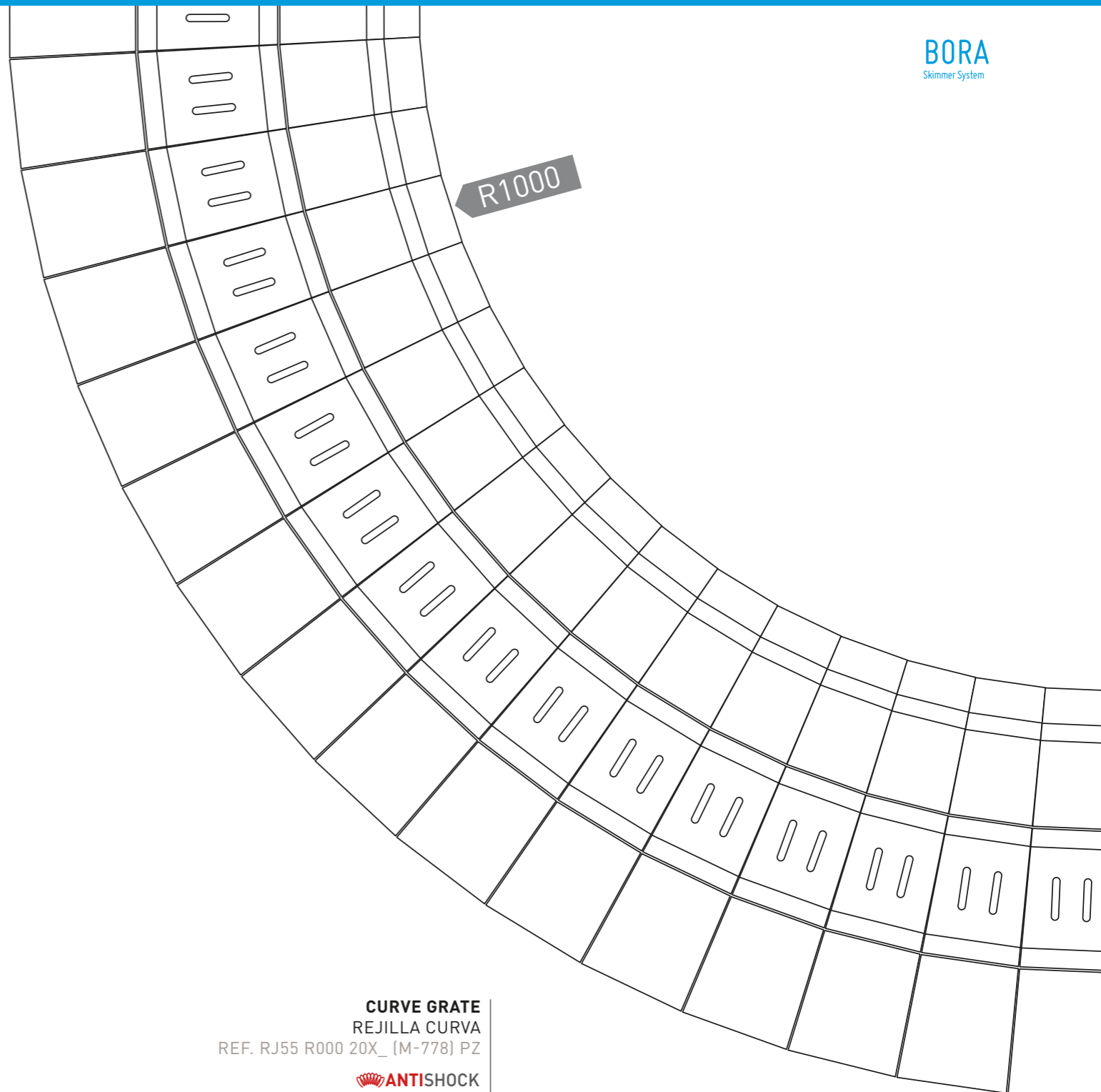
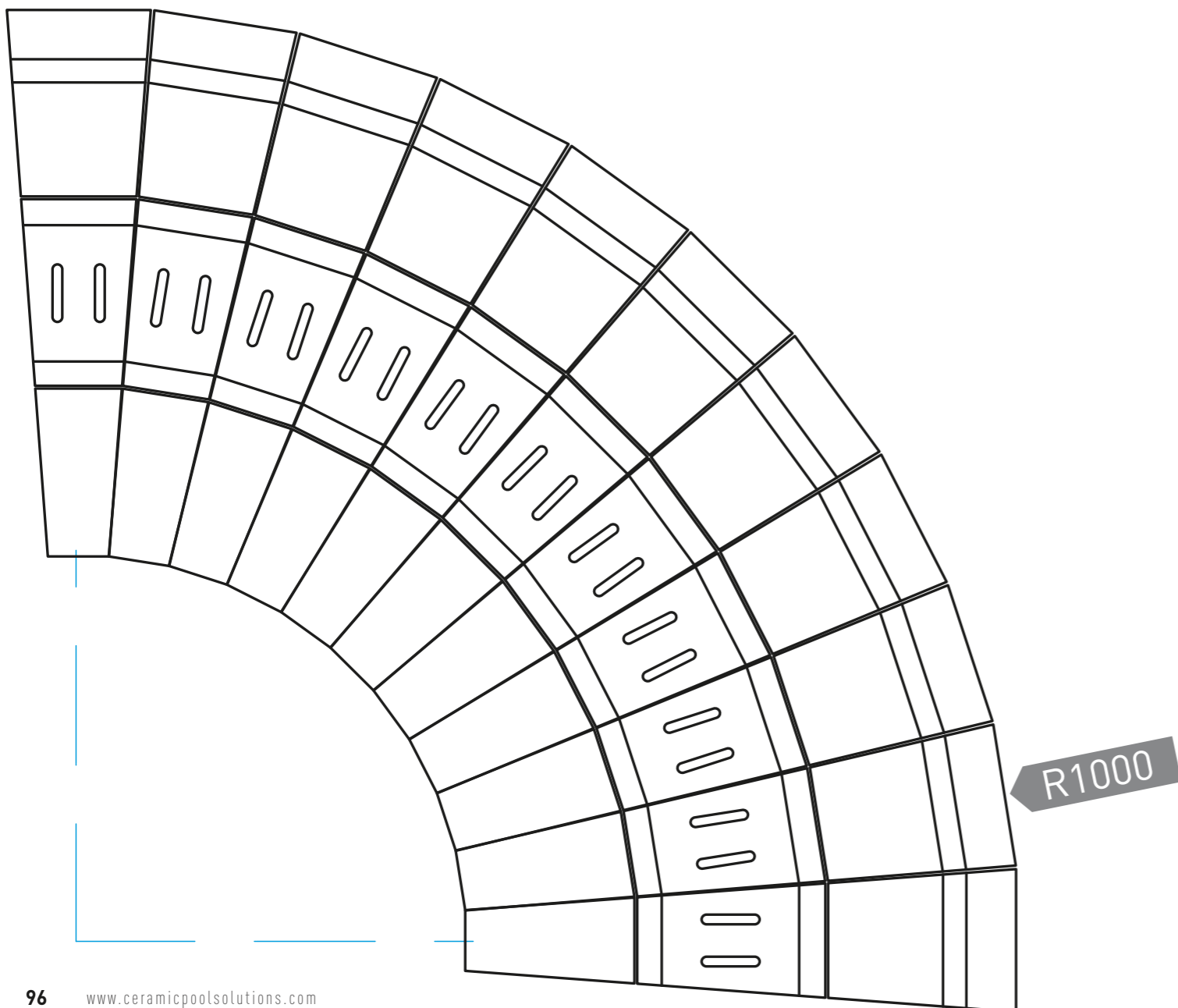
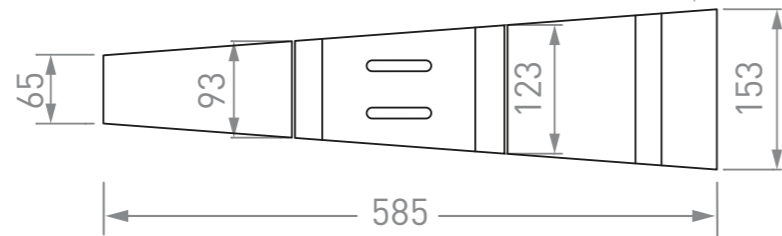

- CURVE GRATE**  
REJILLA CURVA  
REF. RJ55 R000 20X\_ (M-778) PZ  

- CORNER GRATE SUPPORT**  
SOPORTE ESQUINA P/REJILLA  
REF. BSCA RE00 (M-745) PZ
- BORA CURVED EDGE**  
BORDE CURVO BORA  
REF. BPBO RI00 20X\_ (M-767) 2 PZS

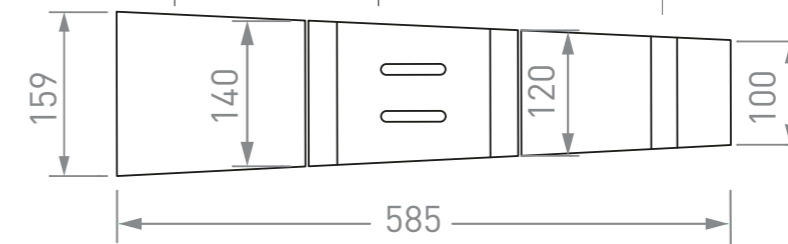



## HAWAII



**OVERFLOWING SYSTEM**  
SISTEMA DESBORDANTE

Hawaii System + RJ88 Grate System  
Color: Stromboli Light

# HAWAII OVERFLOWING COPING SYSTEM

## SISTEMA DE CORONACIÓN DESBORDANTE



**HAWAII EDGE**  
BORDE HAWAII  
Ref. BPHA 0000 25x50 (M-709) pz  
MONOBLOCK

R12 -30%

OVERFLOWING >>5%

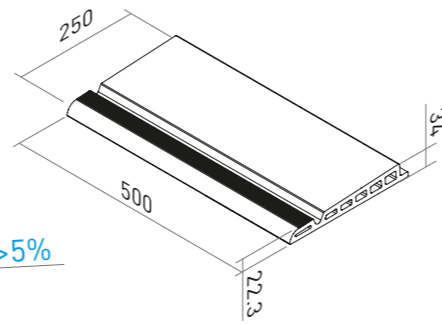

**CERAMIC DRAIN GRATE**  
REJILLA DE DRENAJE CERÁMICA  
Ref. RJ88 0000 25x50 (M-516) pz  
MONOBLOCK



Component: Grate Rubber  
Componente: Goma p/Rejilla  
Art. 6491 (M-250) ml

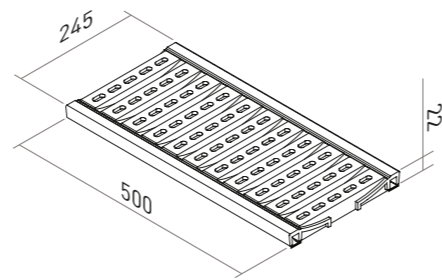

Breaking Load  
Fuerza de rotura >3500N

EN ISO 10545-4

Drain  
Desagüe

> 57 m³/hora



**GRATE SUPPORT**  
SOPORTE P/REJILLA  
Ref. BSCA 0000 18x50 (M-729) pz  
MONOBLOCK

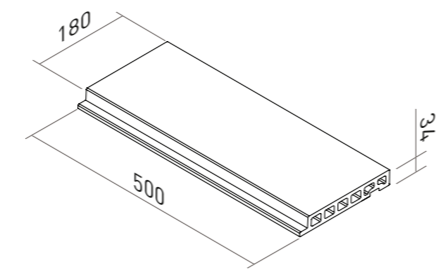

Worldwide Patent  
Patente Mundial



### OVERFLOWING SYSTEM DETAIL DETALLE SISTEMA DESBORDANTE

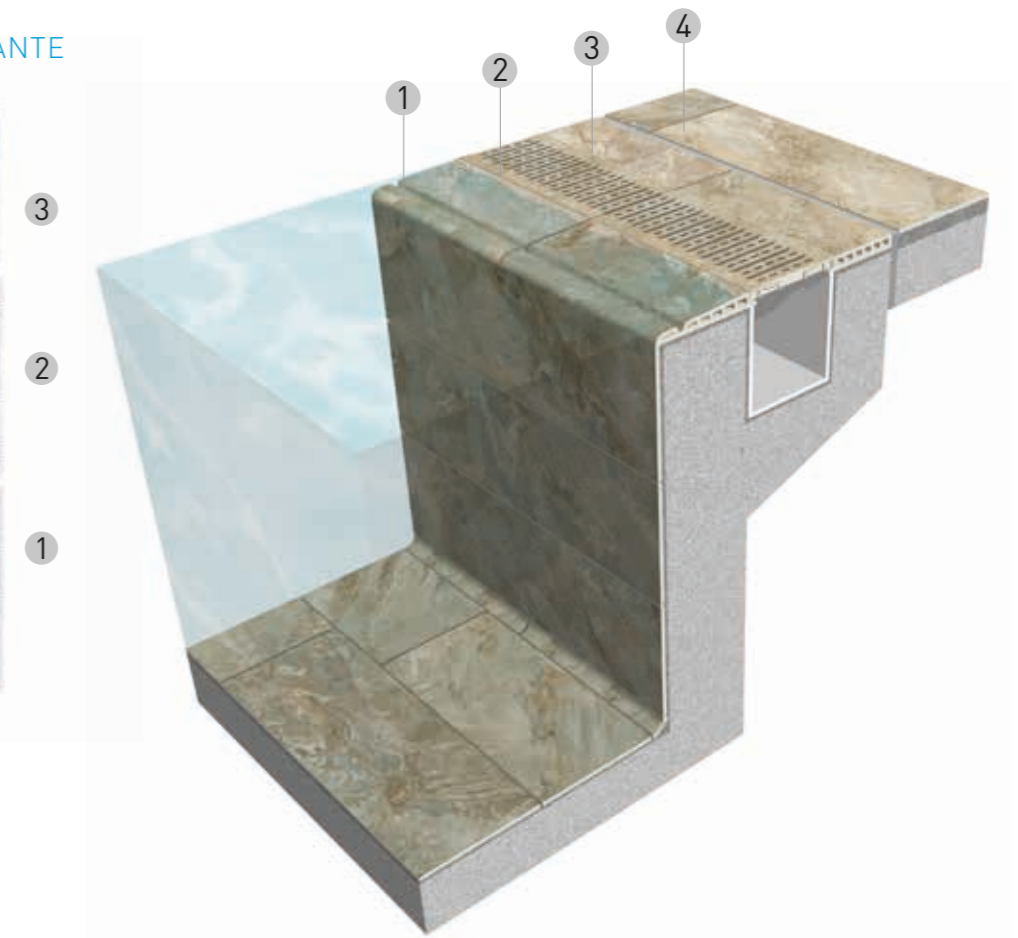

- 1\_ HAWAII EDGE  
BORDE HAWAII
- 2\_ CERAMIC GRATE RJ88  
REJILLA CERÁMICA RJ88
- 3\_ HAWAII GRATE SUPPORT  
SOPORTE REJILLA HAWAII
- 4\_ TILES  
BASES

#### TECHNICAL INFORMATION INFORMACIÓN TÉCNICA

**MONOBLOCK** ONE PIECE WITHOUT GLUED  
UNA PIEZA, SIN PEGADO



UNE ENV 12633  
Clase 3



DIN 51130  
R12



DIN 51097  
Clase C



EN ISO 10545-12



EN ISO 10545-13  
GA / GLA / GHA



NOISELESS  
SILENCIOSO



LONG LIFE  
LARGA VIDA



EASY  
FÁCIL



Rainforest Blanco



Rainforest Musgo



Stromboli Light

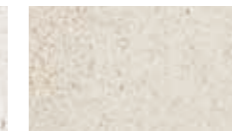

Stromboli Cream



Stromboli Silver



Sea Rock Caramel

## CORNER SOLUTION SOLUCIÓN ESQUINA



### CORNER GRATE SUPPORT SOPORTE ESQUINA P/REJILLA

- ① Ref. BSCA EE00 18x50 **(M-733) 2 pz**
- ④ Ref. BSCA EI00 18x50 **(M-733) 2 pz**

### CORNER GRATE ESQUINA REJILLA

- ② Ref. RJ88 E000 25 **(M-719) 1pz**  
**MONOBLOCK**
- Grates RJ55, RJ67 and RJ70 can also be used  
Compatible con las rejillas RJ55, RJ67 y RJ70*

### HAWAII EDGE PACK PACK BORDE HAWAII

- ③ Ref. BPHA EI00 25x50 **(M-734) 2pz**
- ⑤ Ref. BPHA EE00 25x50 **(M-734) 2pz**

## CURVE SOLUTION SOLUCIÓN CURVA



Special Projects, consult factory. Extra cost Ref. 6624 **(M-600) pz**  
Proyectos especiales consultar con fábrica. Coste extra Ref. 6624 **(M-600) pz**

### CURVED GRATE SUPPORT SOPORTE P/REJILLA CURVA

- ① Ref. BSCA RE00 **(M-745) pz**
- ④ Ref. BSCA RI00 **(M-745) pz**

### CURVE GRATE REJILLA CURVA

- ② Ref. RJ88 RI01 25 **(M-583) 11 pz**
- Grate bolts / included  
Pernos rejilla / incluidos  
Art. 6493 **(M-704) 25 pz***

### HAWAII CURVE EDGE BORDE CURVO HAWAII

- ③ Ref. BPHA RI00 **(M-414,5) pz**
- ⑤ Ref. BPHA RE00 **(M-414,5) pz**



Grate support  
Soporte rejilla

RJ88 0000 ceramic grate  
Rejilla cerámica RJ88 0000

Hawaii pool edge  
Borde piscina Hawaii

Grate support 18x50  
Soporte rejilla 18x50  
Ref. BSCA 0000 18x50

Ceramic grate 25x50  
Rejilla cerámica 25x50  
Ref. RJ88 0000 25x50

Hawaii pool edge 25x50  
Borde piscina Hawaii 25x50  
Ref. BPHA 0000 25x50

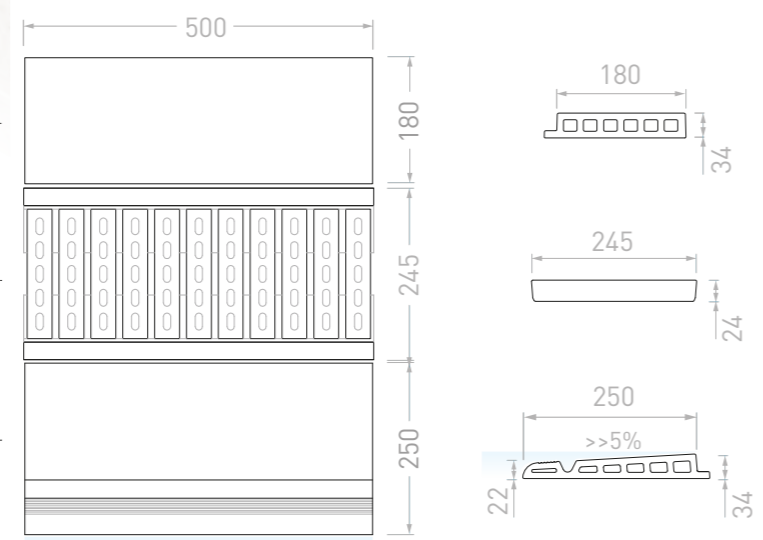

### Straight system pieces with RJ88 Grate

Sistema de piezas en recto con Rejilla RJ88

DWG HA\_160517

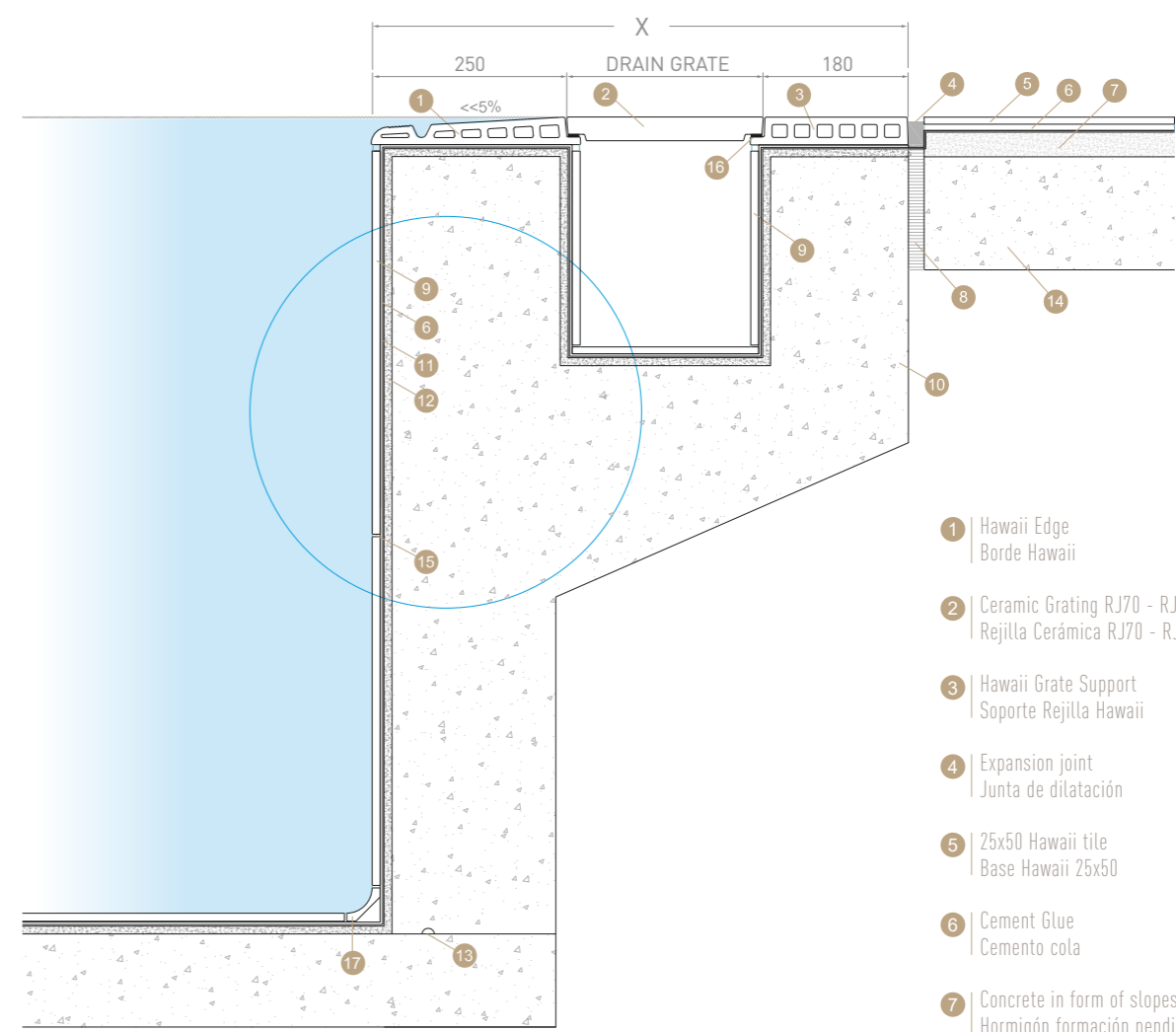

- 1 Hawaii Edge  
Borde Hawaii
- 2 Ceramic Grating RJ70 - RJ88  
Rejilla Cerámica RJ70 - RJ88
- 3 Hawaii Grate Support  
Soporte Rejilla Hawaii
- 4 Expansion joint  
Junta de dilatación
- 5 25x50 Hawaii tile  
Base Hawaii 25x50
- 6 Cement Glue  
Cemento cola
- 7 Concrete in form of slopes  
Hormigón formación pendientes
- 8 Porexpan
- 9 Interior Pool tile  
Revestimiento interior de piscina
- 10 Concrete pool vessel  
Vaso de piscina de hormigón
- 11 Waterproofing  
Impermeabilización
- 12 Rendering regularisations  
Revoco de regularización
- 13 Expansion joint  
Junta de expansión
- 14 Concrete deck  
Solera de hormigón
- 15 Grouted paste  
pasta para rejuntar
- 16 Grate rubber  
Goma para rejilla
- 17 Semi-circular piece  
Media caña

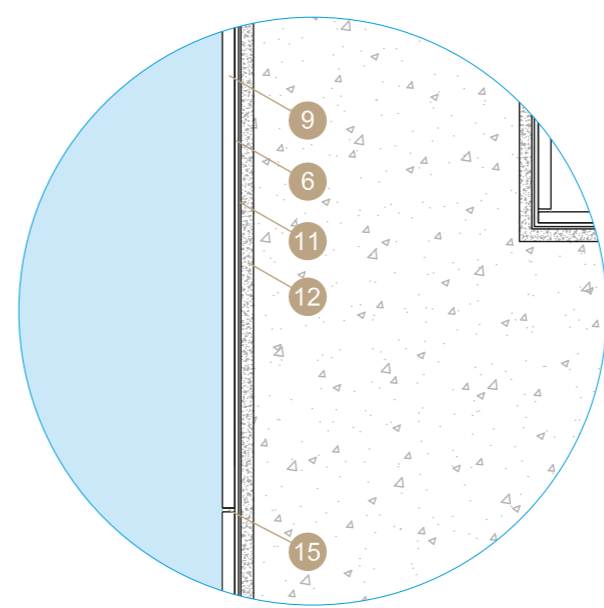

### Hawaii detail system

Detalle del sistema Hawaii

DWG HA\_160517

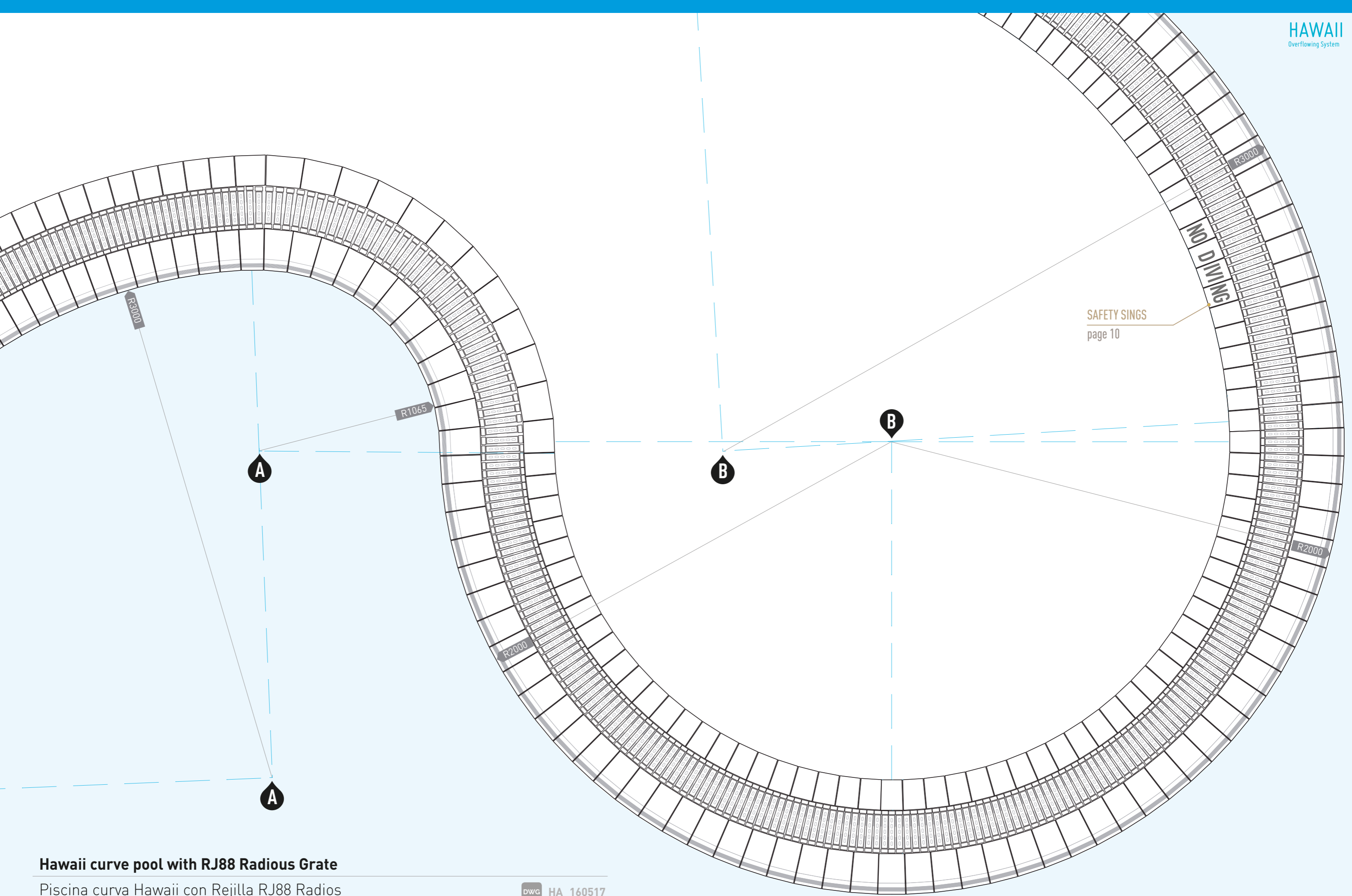

**Hawaii curve pool with RJ88 Radiused Grate**

Piscina curva Hawaii con Rejilla RJ88 Radios

DWG HA\_160517



## VIERTEAGUAS



**OVERFLOWING & SKIMMER SYSTEM**  
SISTEMA DESBORDANTE Y SKIMMER

Sill System  
Color: Stromboli Cream

# VIERTEAGUAS

OVERFLOWING & SKIMMER SYSTEM  
SISTEMA DESBORDANTE Y SKIMMER

## SILL COPING CORONACIÓN CON VIERTEAGUAS



Sill  
Vierteaguas  
**MONOBLOCK**  
18x50 cm (M-392) pz

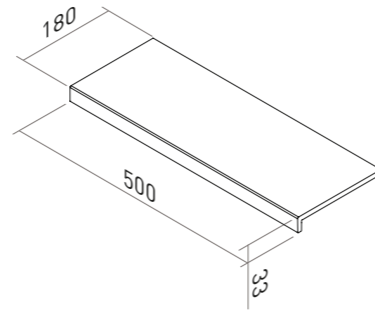

STROMBOLI\_cream

## INFINITY POOL SOLUTION SOLUCIÓN PISCINA INFINITY

### IDEAL FOR PLANTERS IDEAL PARA JARDINERAS

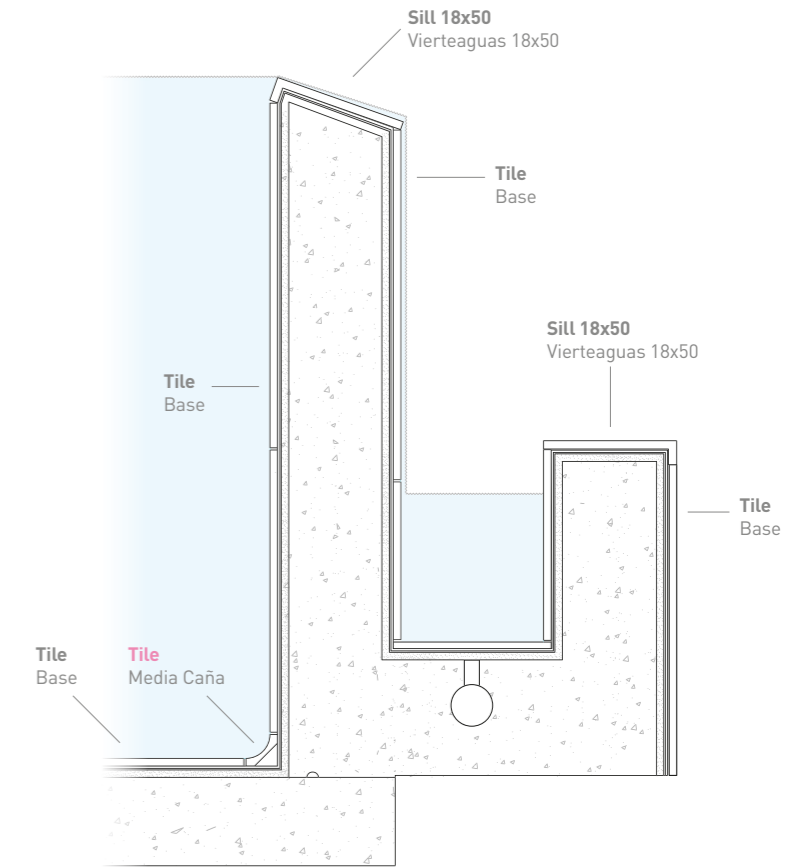
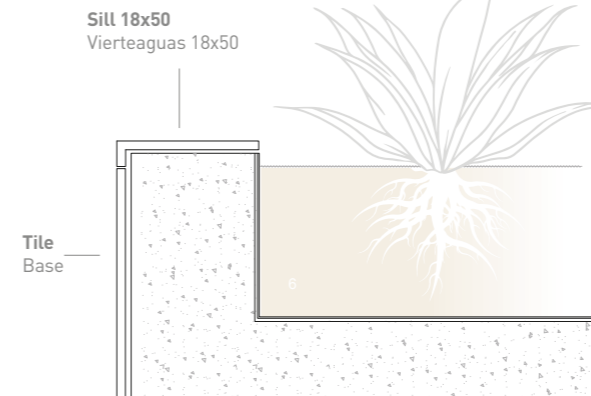

SEA ROCK\_caramel

### TECHNICAL INFORMATION INFORMACIÓN TÉCNICA

**MONOBLOCK** ONE PIECE WITHOUT GLUED  
UNA PIEZA, SIN PEGADO



UNE ENV 12633  
Clase 3



DIN 51130  
R10



DIN 51097  
Clase C



EN ISO 10545-12  
✓



EN ISO 10545-13  
GA / GLA / GHA



NOISELESS  
SILENCIOSO



LONG LIFE  
LARGA VIDA



EASY  
FÁCIL



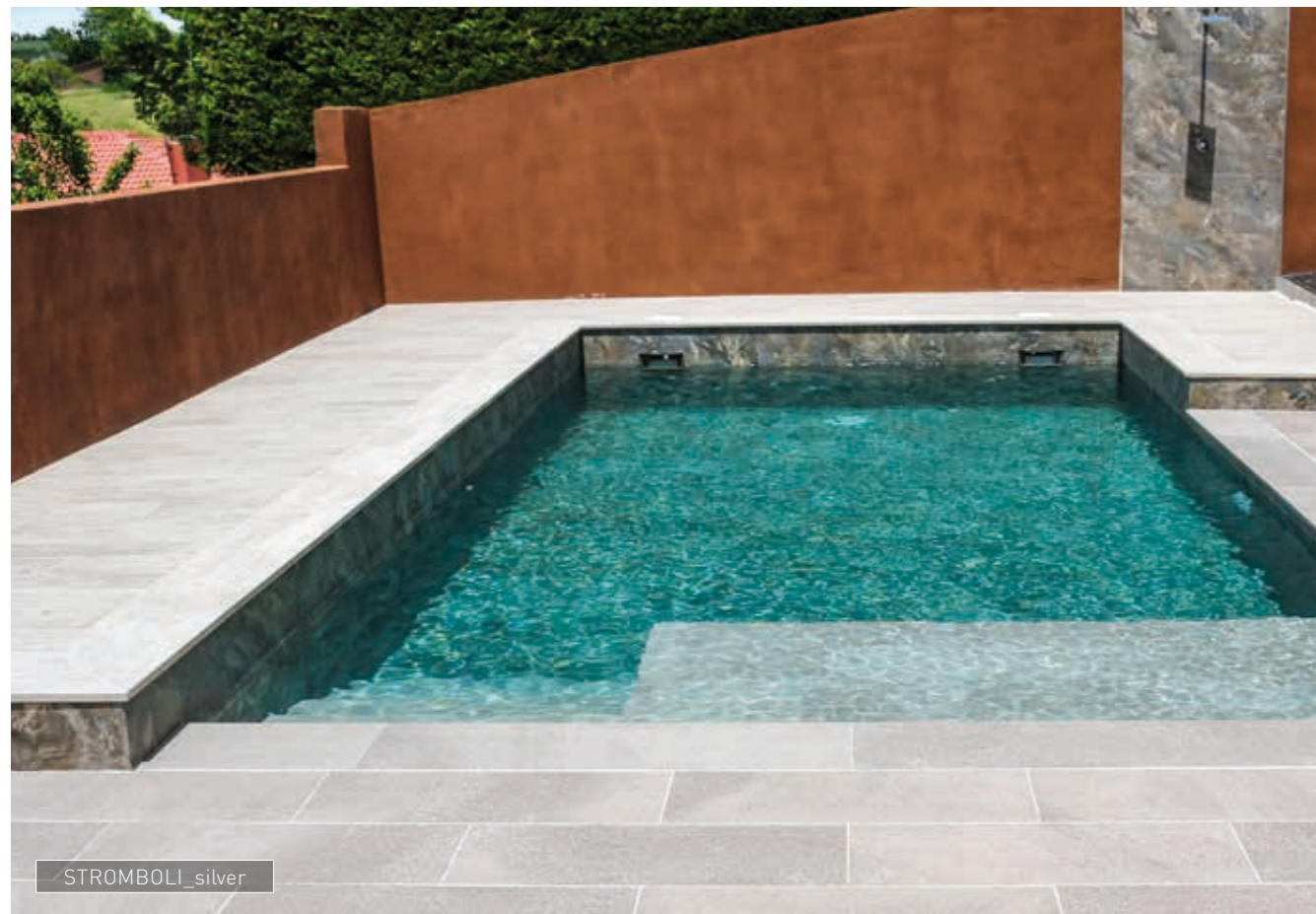

**INFINITY POOL SOLUTION**  
SOLUCIÓN PISCINA INFINITY

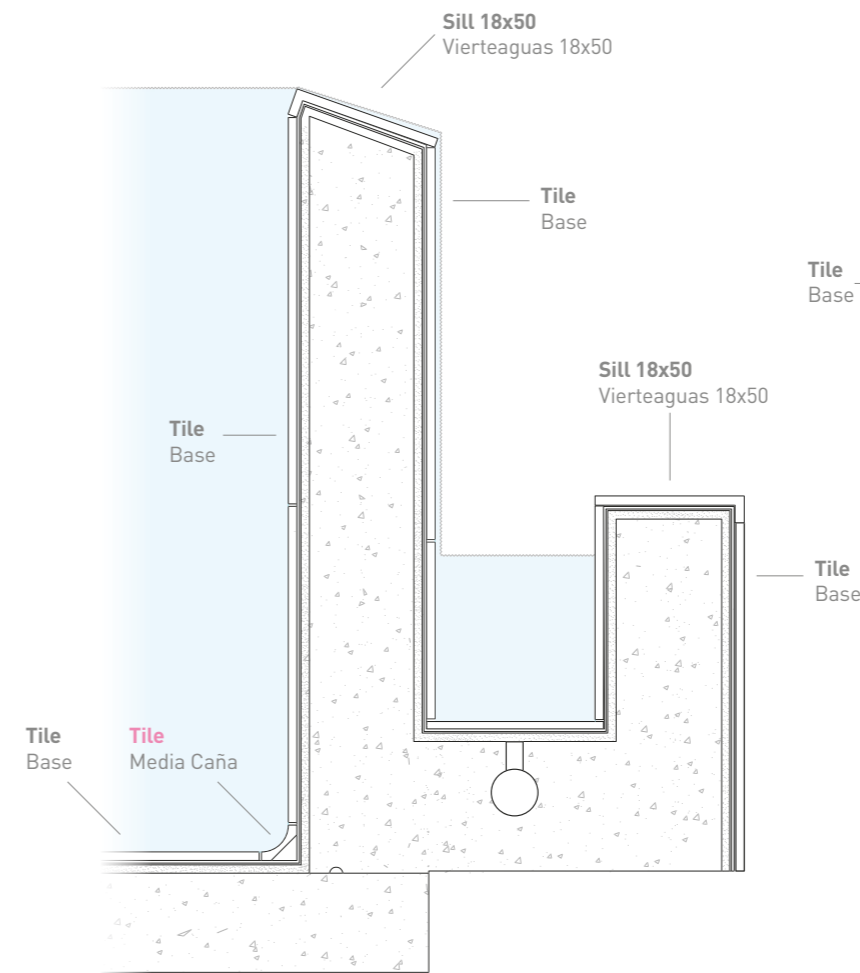

**IDEAL FOR PLANTERS**  
IDEAL PARA JARDINERAS

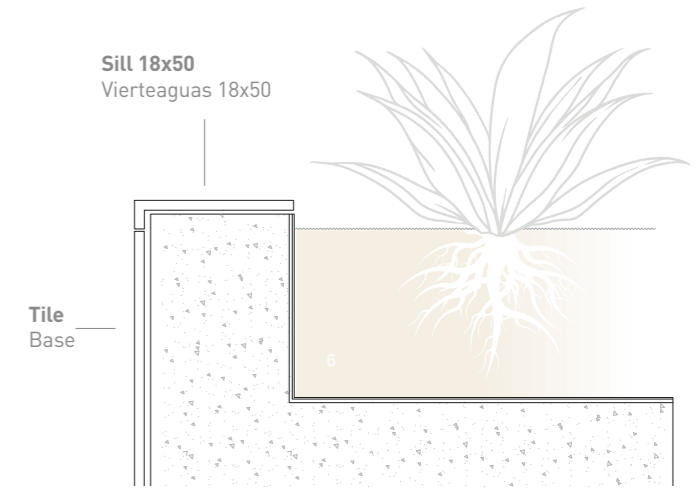

**POOL EDGE SOLUTION**  
SOLUCIÓN BORDE PISCINA

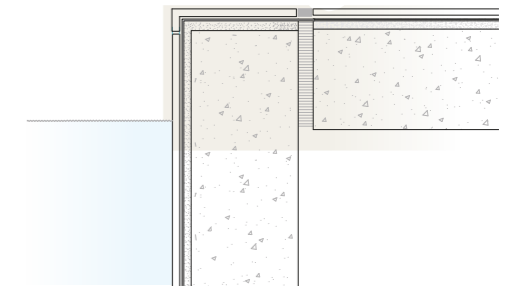

Step System  
Color: Stromboli Light

## STEP / PELDAÑO 120x33



**OVERFLOWING & SKIMMER SYSTEM**  
SISTEMA DESBORDANTE Y SKIMMER

## STEP COPING CORONACIÓN CON PELDAÑO

Complete step  
Peldaño completo  
**MONOBLOCK**  
120x33 (M-419) pz

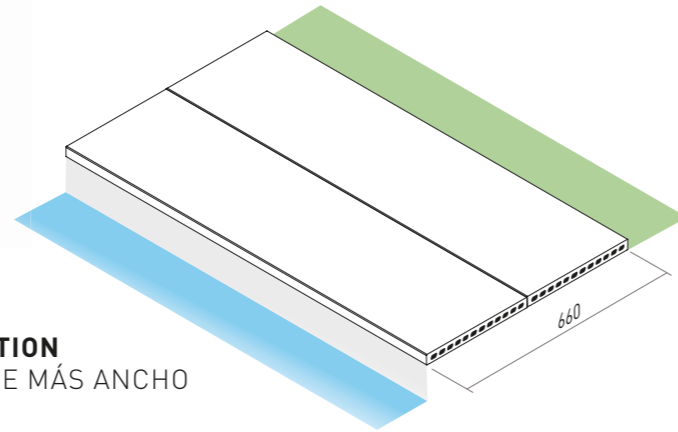
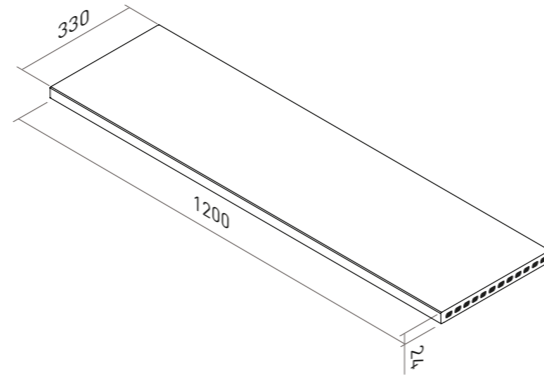

**WIDTH EXTRA EDGE SOLUTION**  
SOLUCIÓN PARA UN BORDE MÁS ANCHO

## Angular finishes for 120x33 step Terminaciones angulares para peldaño 120x33



120x33 Peldaño recto  
**MONOBLOCK**  
(M-739) pz



120x33 Peldaño recto 1 Tapa  
(M-787) pz



120x33 Peldaño recto 2 Tapas  
(M-788) pz



## STEP 120

**BASIC PIECES.** With our products we take a step further in integrating your pool with the environment, offering the possibility of combining any of our pool systems with the finish of your terrace.



CARMEL

120x33 Peldaño florentino  
**MONOBLOCK**  
(M-742) pz

47.2x12.9 in. | 120x33 cm  
0.43 in. | 1.1 cm  
0.94 in. | 3.4 cm

## PELDAÑO DE 120

**PIEZAS BÁSICAS.** Con nuestros productos damos un paso más en la integración de su piscina con el medio ambiente, ofreciendo la posibilidad de combinar cualquiera de nuestros sistemas de piscinas con el acabado de su terraza.



NORDIC

120x33 Peldaño recto  
**MONOBLOCK**  
(M-739) pz

47.2x12.9 in. | 120x33 cm  
0.43 in. | 1.1 cm  
1.33 in. | 3.4 cm



**SKIMMER SYSTEM**  
SISTEMA SKIMMER

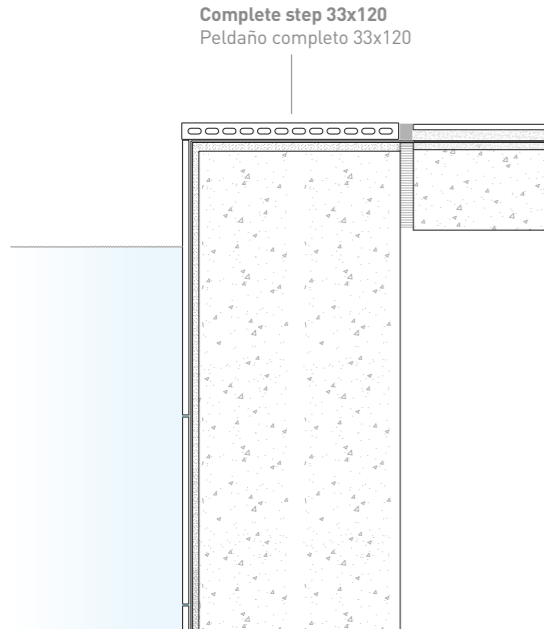

**OVERFLOWING SYSTEM**  
SISTEMA DESBORDANTE

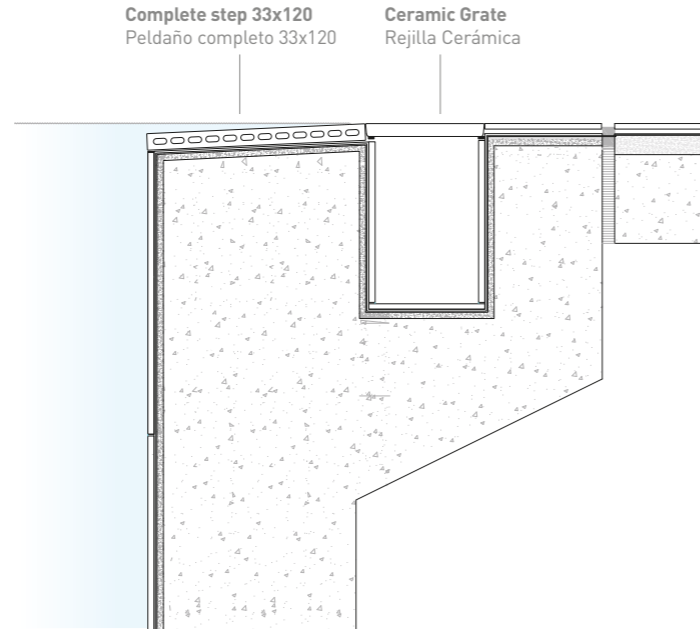

**Complete step solutions inside pools**

Solución peldaño para el interior de la piscina

DWG PC\_160517

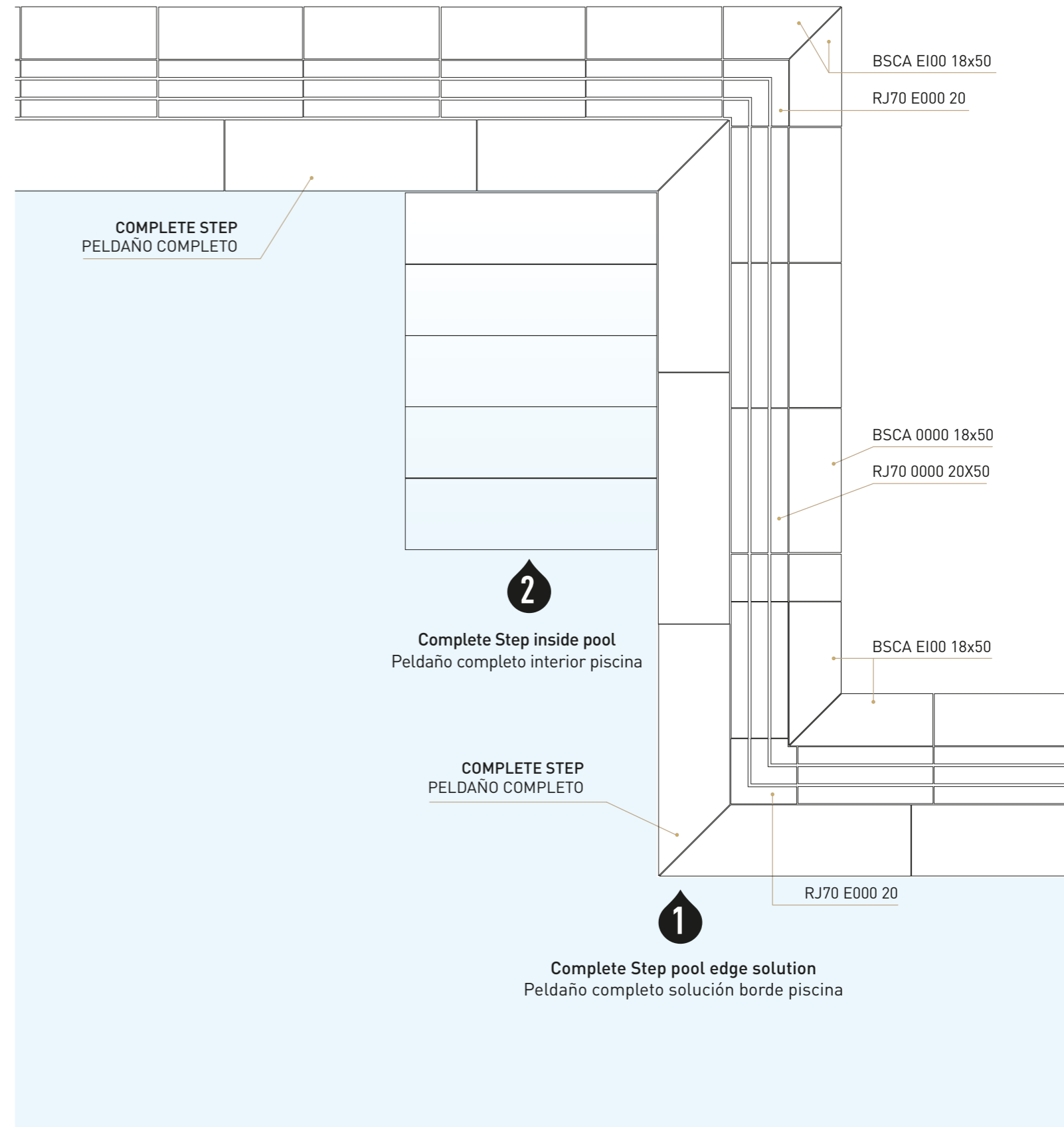

## CERAMIC GRATES



**RJ55 0000 Grate**  
Rejilla RJ55 0000



**RJ67 0000 Grate**  
Rejilla RJ67 0000



**RJ70 0000 Grate**  
Rejilla RJ70 0000



**RJ88 0000 Grate**  
Rejilla RJ88 0000

## RJ55 Grate system

Sistema de Rejilla RJ55

Grate  
Rejilla

20x50 cm

Ref. RJ55 0000 20x50

MONOBLOCK



Ceramic Grate Corner Pack  
Pack Esquina Rejilla Cerámica

20x50 cm

Ref. RJ55 E000 20x\_



Curve Grate  
Rejilla Curva

20x50 cm

Ref. RJ55 RI01 20x\_



Goma Rejilla  
Art. 7966



Cómodo  
Comfortable



Piezas para piscina curva  
Curved pool pieces



Soluciones de esquina  
Corner solutions

## RJ55 Grate system technical characteristics

Características técnicas del sistema de Rejilla RJ55



Antideslizante  
Antislip | UNE ENV 12633  
**Clase 3**



Antideslizante  
Antislip | DIN 51130  
**R10**

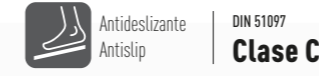

Antideslizante  
Antislip | DIN 51097  
**Clase C**

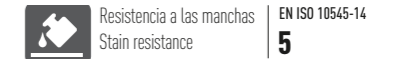

Resistencia a las manchas  
Stain resistance | EN ISO 10545-14  
**5**

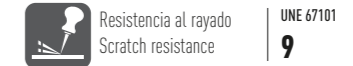

Resistencia al rayado  
Scratch resistance | UNE 67101  
**9**



Chemical resistance  
Resistencia química | EN ISO 10545-13  
**GA / GLA / GHA**

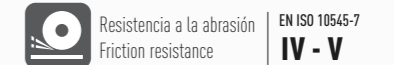

Resistencia a la abrasión  
Friction resistance | EN ISO 10545-7  
**IV - V**

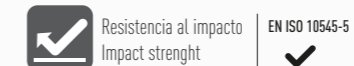

Resistencia al impacto  
Impact strenght | EN ISO 10545-5  
✓

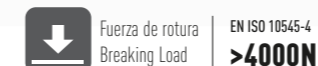

Fuerza de rotura  
Breaking Load | EN ISO 10545-4  
**>4000N**



Drain  
Desagüe | **> 19.4 m³/hora**



Resistencia a la helada  
Frost resistance | EN ISO 10545-12  
✓

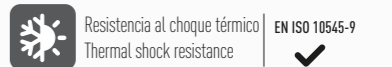

Resistencia al choque térmico  
Thermal shock resistance | EN ISO 10545-9  
✓



Tolerancia dimensional  
Dimensional tolerance | EN ISO 10545-2  
✓

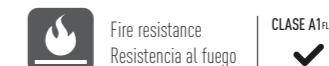

Fire resistance  
Resistencia al fuego | **CLASE A1<sub>n</sub>**  
✓

Porcelain tile  
Gres porcelánico

### TECHNICAL INFORMATION INFORMACIÓN TÉCNICA

**MONOBLOCK** ONE PIECE WITHOUT GLUED  
UNA PIEZA, SIN PEGADO



UNE ENV 12633  
**Clase 3**



DIN 51130  
**R10**



DIN 51097  
**Clase C**



EN ISO 10545-12  
✓



EN ISO 10545-13  
**GA / GLA / GHA**



NOISELESS  
SILENCIOSO



LONG LIFE  
LARGA VIDA



EASY  
FÁCIL

## RJ67 Grate system

Sistema de Rejilla RJ67

### Grate Rejilla

25x50 cm

Ref. RJ67 0000 25x50

MONOBLOCK



### Ceramic Grate Corner Pack Pack Esquina Rejilla Cerámica

25x50 cm

Ref. RJ66 0000 25x50



### Curve Grate Rejilla Curva

25x50 cm

Ref. RJ66 0000 25x50



### Goma Rejilla Art. 7966

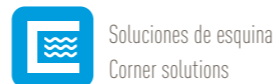

## RJ67 Grate system technical characteristics

Características técnicas del sistema de Rejilla RJ67

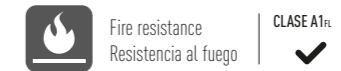
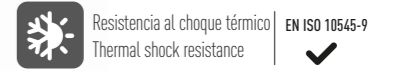
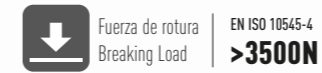
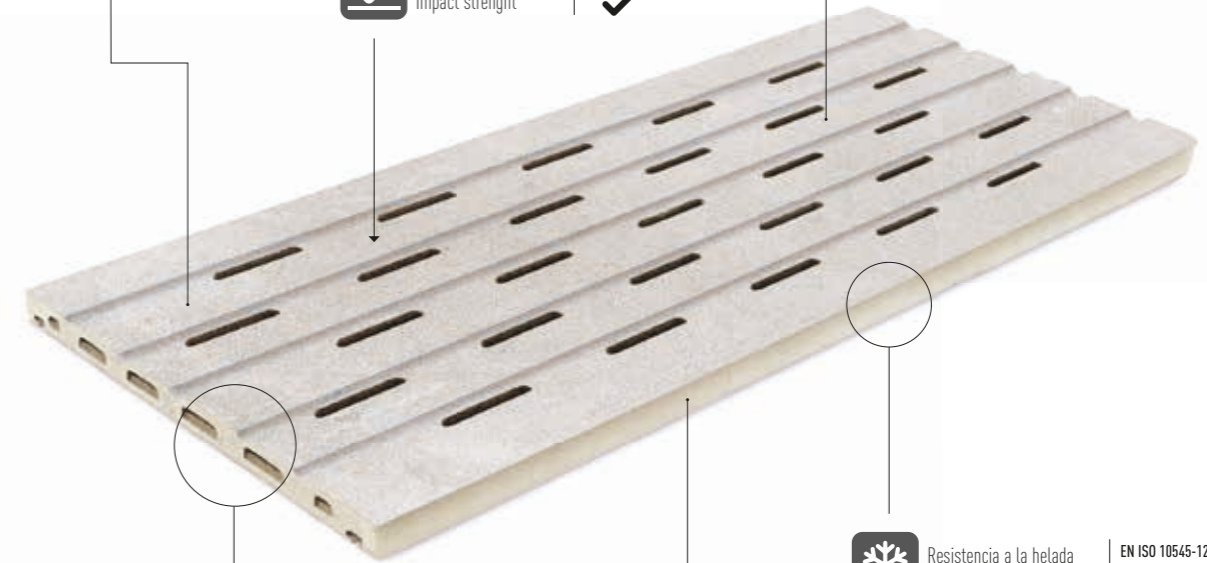
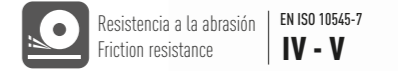
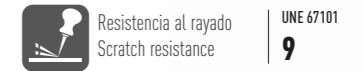
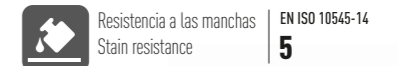
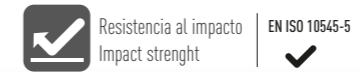
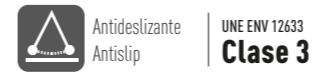

### TECHNICAL INFORMATION INFORMACIÓN TÉCNICA

**MONOBLOCK** ONE PIECE WITHOUT GLUED  
UNA PIEZA, SIN PEGADO



## RJ70 Grate system

Sistema de Rejilla RJ70

### Grate Rejilla

20x50 cm

Ref. RJ70 0000 20x50

MONOBLOCK



### Corner Grate Rejilla Esquina

20x20 cm

Ref. RJ70 E000 20

MONOBLOCK



### Goma Rejilla Art. 6491



Cómodo  
Comfortable

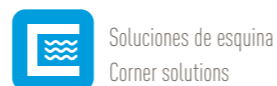

Soluciones de esquina  
Corner solutions

## RJ70 Grate system technical characteristics

Características técnicas del sistema de Rejilla RJ70

Antideslizante  
Antislip | UNE ENV 12633  
**Clase 3**

Antideslizante  
Antislip | DIN 51130  
**R10**

Antideslizante  
Antislip | DIN 51097  
**Clase C**

Resistencia al impacto  
Impact strenght | EN ISO 10545-5  
✓

Resistencia a las manchas  
Stain resistance | EN ISO 10545-14  
**5**

Resistencia al rayado  
Scratch resistance | UNE 67101  
**9**

Chemical resistance  
Resistencia química | EN ISO 10545-13  
**GA / GLA / GHA**

Resistencia a la abrasión  
Friction resistance | EN ISO 10545-7  
**IV - V**

Fuerza de rotura  
Breaking Load | EN ISO 10545-4  
**>4000N**

Drain  
Desagüe | **> 9.7 m³/hora**

Absorción de agua  
Water absorption | EN ISO 10545-3  
**< 0,5 %**

Resistencia a la helada  
Frost resistance | EN ISO 10545-12  
✓

Resistencia al choque térmico  
Thermal shock resistance | EN ISO 10545-9  
✓

Tolerancia dimensional  
Dimensional tolerance | EN ISO 10545-2  
✓

Fire resistance  
Resistencia al fuego | **CLASE A1<sub>fl</sub>**  
✓

### TECHNICAL INFORMATION INFORMACIÓN TÉCNICA

**MONOBLOCK** ONE PIECE WITHOUT GLUED  
UNA PIEZA, SIN PEGADO

UNE ENV 12633  
**Clase 3**

DIN 51130  
**R10**

DIN 51097  
**Clase C**

EN ISO 10545-12  
✓

EN ISO 10545-13  
**GA / GLA / GHA**

NOISELESS  
SILENCIOSO

LONG LIFE  
LARGA VIDA

EASY  
FÁCIL



## RJ88 Grate system

Sistema de Rejilla RJ88

**Grate**  
**Rejilla**



24.5x50 cm

Ref. RJ88 0000 25x50

MONOBLOCK

**Corner Grate**  
**Rejilla Esquina**



24.5x24.5 cm

Ref. RJ88 E000 25

MONOBLOCK

**Curve Grate**  
**Rejilla Curva**



24.5x50 cm

Ref. RJ88 RI01 25 - 11pz

FLEXIBLE

**Goma Rejilla**  
**Art. 6491**



Cómodo  
Comfortable



Piezas para piscina curva  
Curved pool pieces



Soluciones de esquina  
Corner solutions

## RJ88 RI00 Curved grate mounting

Detalle de colocación de las rejillas

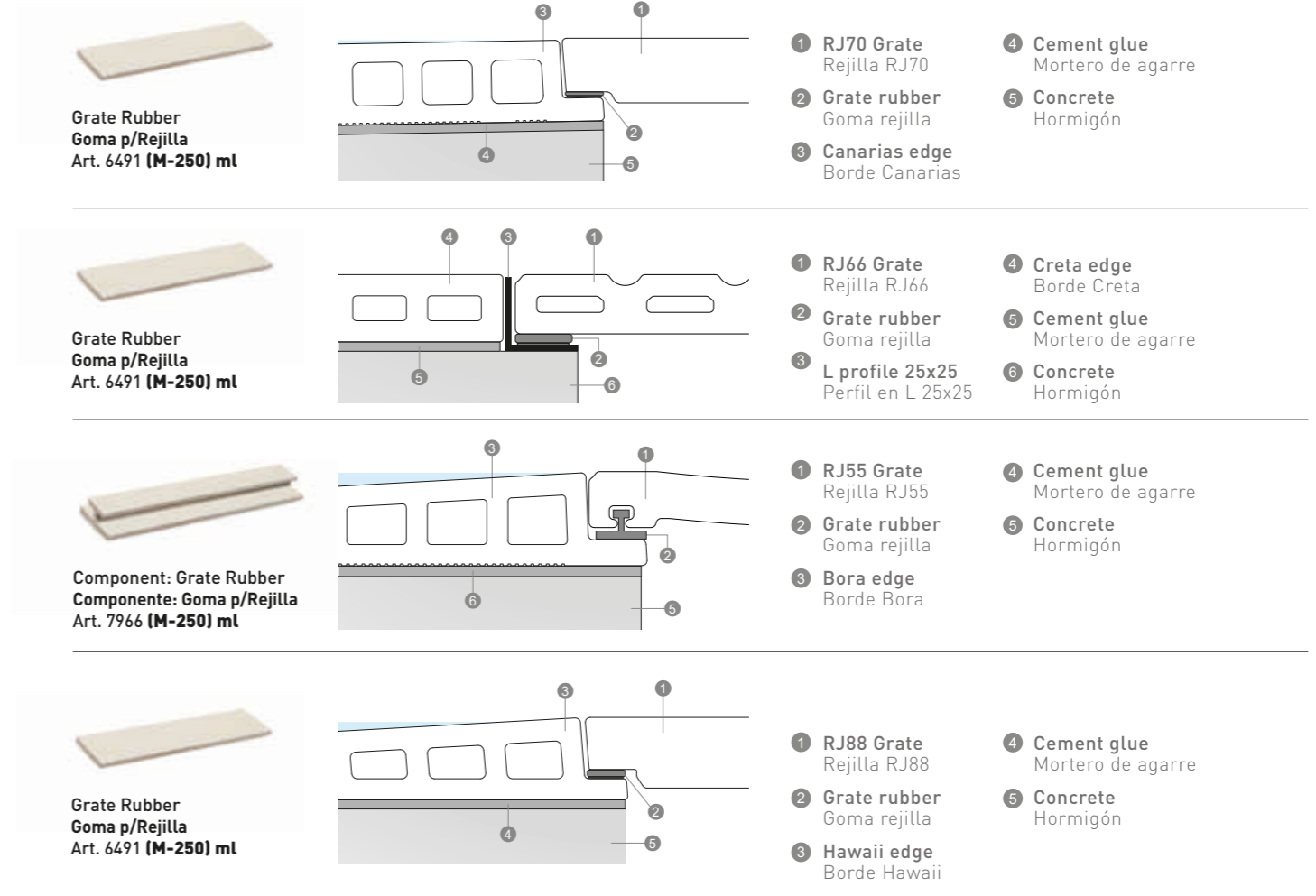

Instalación de la rejilla curva RJ88 RI00

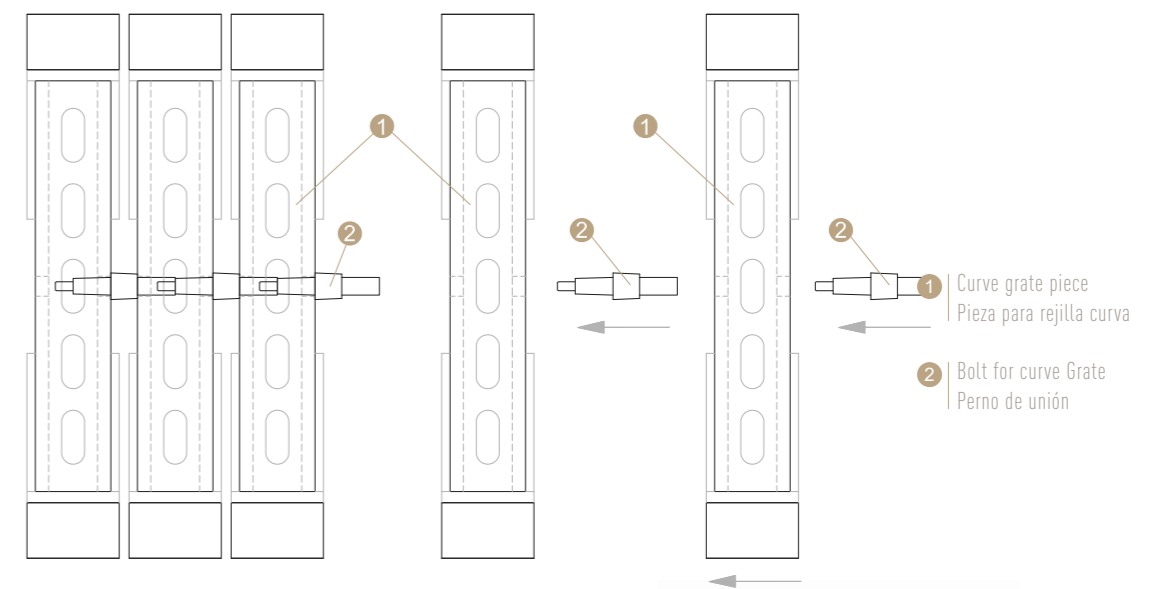

**TECHNICAL INFORMATION**  
INFORMACIÓN TÉCNICA

**MONOBLOCK** ONE PIECE WITHOUT GLUED  
UNA PIEZA, SIN PEGADO



## POOL SHELL MEDIA CAÑA



**Cove pool inner**  
Media caña interior



**Cove pool inner corner**  
Media caña esquina interior



**Cove pool inner angle**  
Media caña ángulo interior

# POOL SHELL SYSTEM

SISTEMA MEDIA CAÑA



① COVE POOL INNER  
MDCA I000  
[M-773] PZ



② COVE POOL OUTER  
MDCA E000  
[M-773] PZ



③ COVE POOL INNER CORNER  
MDCA EI00  
[M-774] PZ



④ COVE POOL OUTER CORNER  
MDCA EE00  
[M-774] PZ



⑤ COVE POOL INNER ANGLE  
MDCA AI00  
[M-774] PZ



⑥ COVE POOL OUTER ANGLE  
MDCA AE00  
[M-774] PZ



## TECHNICAL INFORMATION INFORMACIÓN TÉCNICA

**MONOBLOCK** ONE PIECE WITHOUT GLUED  
UNA PIEZA, SIN PEGADO



## POOL SHELL SYSTEM DETAIL DETALLE SISTEMA MEDIA CAÑA

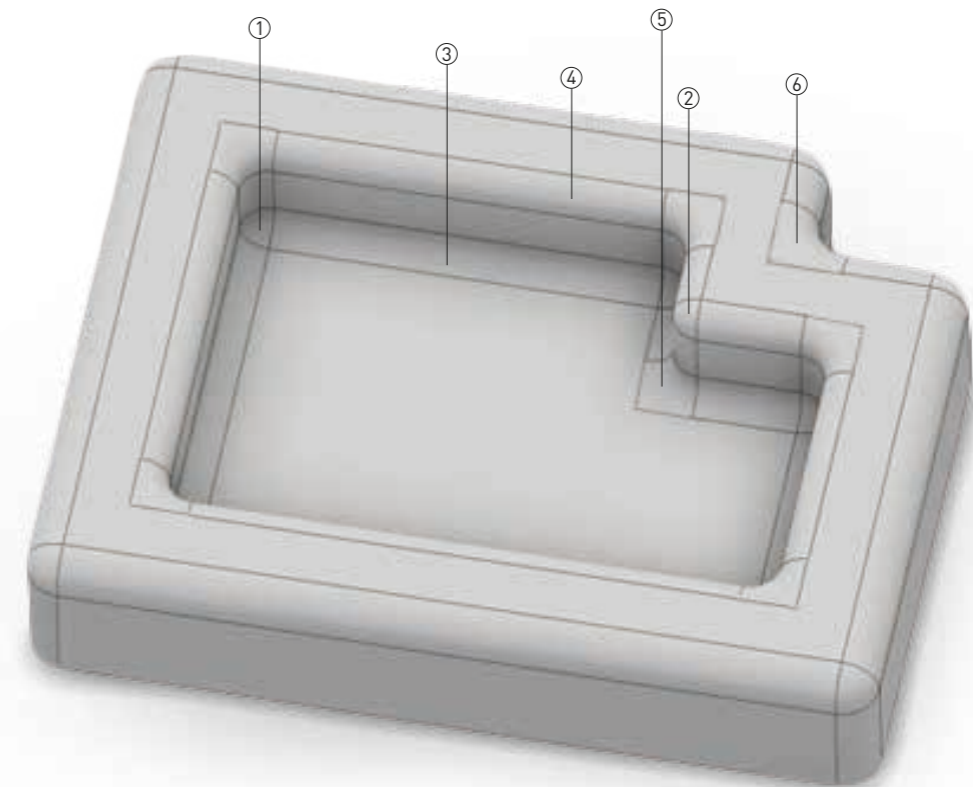

SAFETY POOLS

PISCINAS SEGURAS















# SAFETY

## Technical characteristics

Características técnicas



### Porcelain tile Gres porcelánico

	Friction resistance Resistencia a la abrasión	EN ISO 10545-7 <b>IV - V</b>		Stain resistance Resistencia a las manchas	EN ISO 10545-14 <b>5</b>
	Frost resistance Resistencia a la helada	EN ISO 10545-12 <b>✓</b>		Scratch resistance Resistencia al rayado	UNE 67101 <b>9</b>
	Thermal shock resistance Resistencia al choque térmico	ISO 10545-9 <b>✓</b>		Chemical resistance Resistencia química	EN ISO 10545-13 <b>GA / GLA / GHA</b>
	Bending resistance Resistencia a la flexión	ISO 10545-4 <b>&gt;23N</b>		Water absorption Absorción de agua	EN ISO 10545-3 <b>&lt; 0,5 %</b>
	Antislip Antideslizante	UNE ENV 12633 <b>Clase 3</b>		Fire resistance Resistencia al fuego	CLASE A1 <sub>fl</sub> <b>✓</b>
	Antislip Antideslizante <i>*Hawaii &amp; Mikonos Pool Systems</i>	DIN 51130 <b>R10 / R12*</b>		Impact strength Resistencia al impacto	EN ISO 10545-5 <b>✓</b>
	Antislip Antideslizante	DIN 51097 <b>Clase C</b>		Dimensional tolerance Tolerancia dimensional	EN ISO 10545-2 <b>✓</b>



# SAFETY

## Super-antislip

Súper antideslizante



	Antislip Antideslizante	UNE ENV 12633 <b>Clase 3</b>
	Antislip Antideslizante <i>*Hawaii &amp; Mikonos Pool Systems</i>	DIN 51130 <b>R12*</b>
	Antislip Antideslizante	DIN 51097 <b>Clase C</b>

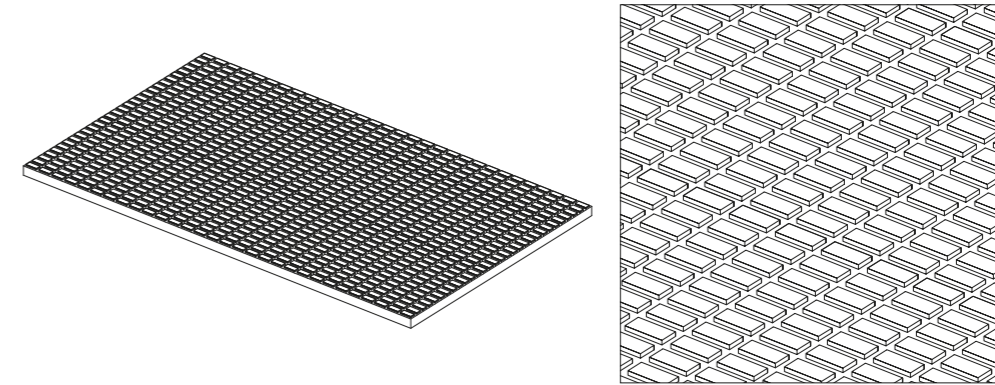

### Super antislip visual effect R12 Efecto visual R12 súper antideslizante



Mikonos System  
Color: Sea Rock Caramel

**SAFETY POOLS**  
PISCINAS SEGURAS



**Antislip**  
**Antideslizante**

Cerámica Mayor offers a super anti-slip finish R12 with a special engraving to maintain safety in the wet areas of terraces pools and spas. Helping to prevent falls and slips.

Cerámica Mayor ofrece un acabado súper antideslizante R12 con un grabado especial para mantener la seguridad en las zonas húmedas de terrazas, piscinas y spas. Ayudando a evitar caídas y resbalones.

**R12** Super antislip  
Súper antideslizante



\*Hawaii & Mikonos Pool Systems



UNE ENV 12633

Clase 3



DIN 51130

R12



DIN 51097

Clase C



Super antislip visual effect R12 - Efecto visual R12 súper antideslizante

**PUBLIC POOLS SOLUTIONS**  
SEÑALIZACIÓN PARA PISCINAS PÚBLICAS

**Public pools warning signaling**

Señalización de advertencia para piscinas públicas



Number dimensions example  
Ejemplo de las dimensiones de los números



\*Safety signs under demand  
\*Piezas de señalización bajo demanda

Warning pool symbols example  
Ejemplo de señales de advertencia



**Brands**  
Marcas



\*Under demand  
\*Bajo demanda

SUP. PIEZA POOL CON TEXTO  
Art. 7087 (M-492) extra cost 1pz

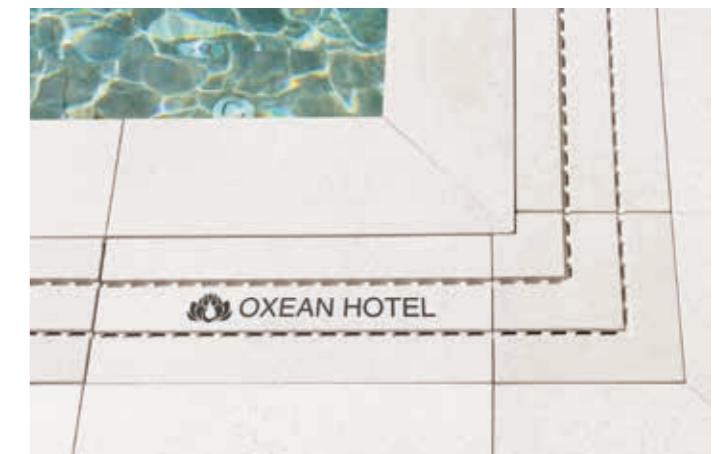

## Custom pieces

Piezas personalizadas



Logotype dimensions with RJ70 grate  
Dimensiones de los logotipos con rejilla RJ70



Logotype dimensions with other pieces  
Dimensiones de los logotipos con otras piezas

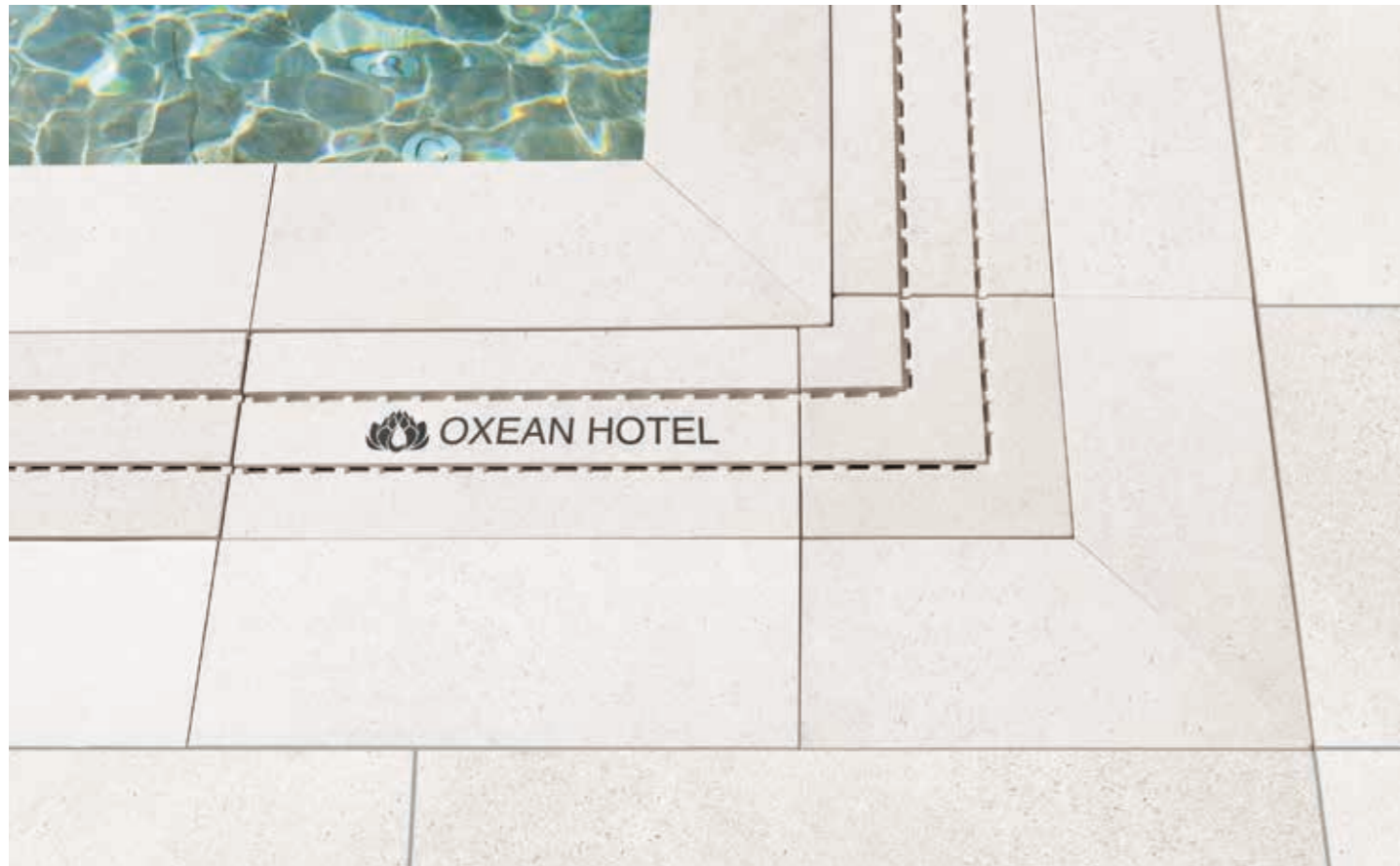



anyplace

[www.ceramicamayor.com](http://www.ceramicamayor.com)

Visit our website for brochures, technical information and certificates

EDITION MARCH 2019

**Mayor**  
CERÁMICA

**CERÁMICA MAYOR S.A.**  
C.I.F. ES A-03108669

Partida Planet, s/n  
03510 Callosa d'En Sarrià.  
(Alicante-España)

T+34 965 881 175  
E [info@ceramicamayor.com](mailto:info@ceramicamayor.com)

**pool** solu  
tions  
by cerámica mayor

TECHNICAL INFORMATION

INFORMACIÓN TÉCNICA